

GF Aquasystem PP-R and PP-RCT Piping Systems



+GF+



Table of Contents

About GF Hakan Plastik	4-5
About Plastics	6-7
Certification Details	8-9
GF Aquasystem PP-R and PP-RCT Piping Systems	10-21
Technical Tables	
• Temperature, Pressure and Service Time Tables	23
Building Technology (BT) Product Range Installation Instructions	24-29
Packing, Stocking and Shipment	
• Packaging	31
• Storage	32
• Transportation	33

About Us





Founded in Switzerland in 1802, Georg Fischer Corporation operates in 3 main business lines: GF Piping Systems, GF Casting Solutions and GF Machining Solutions. Georg Fischer is present in 34 countries with 57 production plants and 136 companies.

GF Piping Systems, the largest business line of Georg Fischer Corporation, is one of the leading companies in plastic and metal piping systems in the world. GFPS produces system solutions and high quality components for the secure transmission of water and gas in industries, utilities and building technology. Reaching out to over 100 countries with its more than 30 production plants, GF Piping Systems acquired **Hakan Plastik** in 2013.

Founded in 1965, **Hakan Plastik** has achieved so many breakthroughs as the first company that produced the silent pipe in Turkey and has reflected the importance that it attaches to development and change to its products and services as well.

GF Hakan Plastik has two production plants in Çerkezköy and Şanlıurfa. With the acquisition by GF, global GF product and process standards applicable worldwide have started to be applied. **GF Hakan Plastik** operates in the fields of Building Technology (BT) and Utility (UT) in plastic piping sector. Exporting its products to over 70 countries, the company has 7 sales areas in Turkey.

GF Hakan Plastik Training and Technology Center provides all its business partners with services with the aim of increasing the knowledge and awareness in the sector through both technical and practical trainings. Reaching out to a wider audience at the center such as the professionals serving the sector, university students and installers and providing diverse training and seminar programs for each stakeholder; the products of **GF Hakan Plastik** are promoted and information is provided about the accurate method of application of the products.



+ Our Market Segments

Based on its experience and high production technology in the sector, GF Hakan Plastik supports its clients in each phase of their projects.

- Building Technology Projects
- Utility Projects
- Industrial Buildings
- Irrigation Projects

+ Our Presence in the World

With our presence as a global brand, we choose to be closer to our clients.

GF Hakan Plastik exports its products to over 70 countries. As Georg Fischer Piping Systems, we provide our clients in over 100 countries with fast response and services.

We act in compliance with the local standards in our over 30 production plants in Europe, Asia and the USA. We ensure fast deliveries with our modern logistics organization deployed at our local distribution hubs.

+ Benefits of Plastics

Plastics are polymers created by the chemical conversion of natural products or synthesized from organic materials. The primary components that make up the building blocks of plastics are long chains of carbon (C) and hydrogen (H) known as monomers.

The raw materials used for the production of plastics are natural compounds such as cellulose, coal, oil and natural gas. In the plastics industry, around 6 % of the petroleum products that come out from refineries is used.

Plastics fall into three main categories on the basis of their internal structure and the resulting mechanical characteristics: thermoplastics, thermosetting plastics and elastomers.

+ Complete Solution Concept

Our wide range of products and services represent our complete solution concept.

With our products intended for diverse sectors, we offer individual and comprehensive system solutions. Focusing on the needs of projects, we optimize the processes and applications integrated into the entire system.

We provide state-of-the-art technology by setting the standards in the market at all times. We always stand by our business partners through our experience in the piping systems and reliable service network.

As an industrial company that stands out with innovative and successful operations ever since our incorporation, we act as a solution point to meet all your needs based on our technical knowledge, specialization and reliability.

Thermoplastics in turn can be split into two main categories as partially-regulated (semi-crystalline) and irregular (amorphous) molecular structures.

- Semicrystalline thermoplastics, which have a partially ordered molecular structure: this category includes the polyolefins (polypropylene, polyethylene, polybutylene) and fluoropolymers (PVDF, PTFE, etc.)
- Amorphous thermoplastics, which have no crystalline regions and no packed molecular structure: this category includes the vinyl chlorides (PVC-U, PVC-C, etc.) and styrenes (ABS, polystyrene, etc.)

Semicrystalline materials are more suitable for hot welding, while amorphous thermoplastics are ideal for cementing or cold welding (solvent cementing).

+ Advantages of Plastics

Thermoplastics obviously demonstrate different characteristics than those of the metals traditionally used for piping.

Metal Systems

High density

- * Crane needed for transport
- * Widely spaced fixings
- * High anchoring forces, fixing required

Thermal conductivity

- * Insulation is always needed to limit heat loss
- Formation of condensation and resulting corrosion *

Corrosion Behaviors

- Galvanic corrosion may occur
- Internal diameter is reduced due to corrosion
Reduction in internal diameter leads to pressure losses

Chemical resistance

- * Low resistance to acids, requiring use of costly alloys
- * Damage from incrustation

Plastic Systems

Low density

- * Can be carried by hand up to d110
- * Closely spaced fixings
- * Limited anchoring forces, simple and economic

Low thermal conductivity

- * Limited heat loss
- Low levels of condensation and resistance to corrosion

High Corrosion Resistance

- No risk of galvanic corrosion risk
- No corrosion and reduction of internal diameter
No pressure losses due to lack of reduction of internal diameter

High chemical resistance

- * In combination with correct jointing methods, at least 25 years of useful life can be warranted
- * No incrustation

+ Service Life Analysis of Plastics

It is the total of all greenhouse gases emitted to the atmosphere during the entire lifetime including the processes for extracting a product having carbon footprint from under the ground, refining, producing, using and disposing of that product.

The following graphics indicate the assessment of the lifetime of thermoplastic piping systems in terms of the quality of their environmental performance and application of them in building technology, industry and water and gas distribution. In the analysis, the impacts of one meter long pipe was compared with the main competitor materials (DN25, DN80, DN150 and DN400) for each of the commonly used plastics. GF supplied this analysis from an independent, Swiss-based organization specialized in environmental performance analyzes, and is based on Ecoinvent, leading lifecycle inventory database in the world.

According to the main results of the study, plastic piping systems demonstrate better performance than metal systems. This finding has been confirmed by other studies conducted in this field.

The main reason for high performance of thermoplastics is that they are lightweight. This ensures key benefits during transport and installation. Fully-plastic solutions are lighter than other piping systems of conventional materials, and this creates significant impacts on carbon footprint.

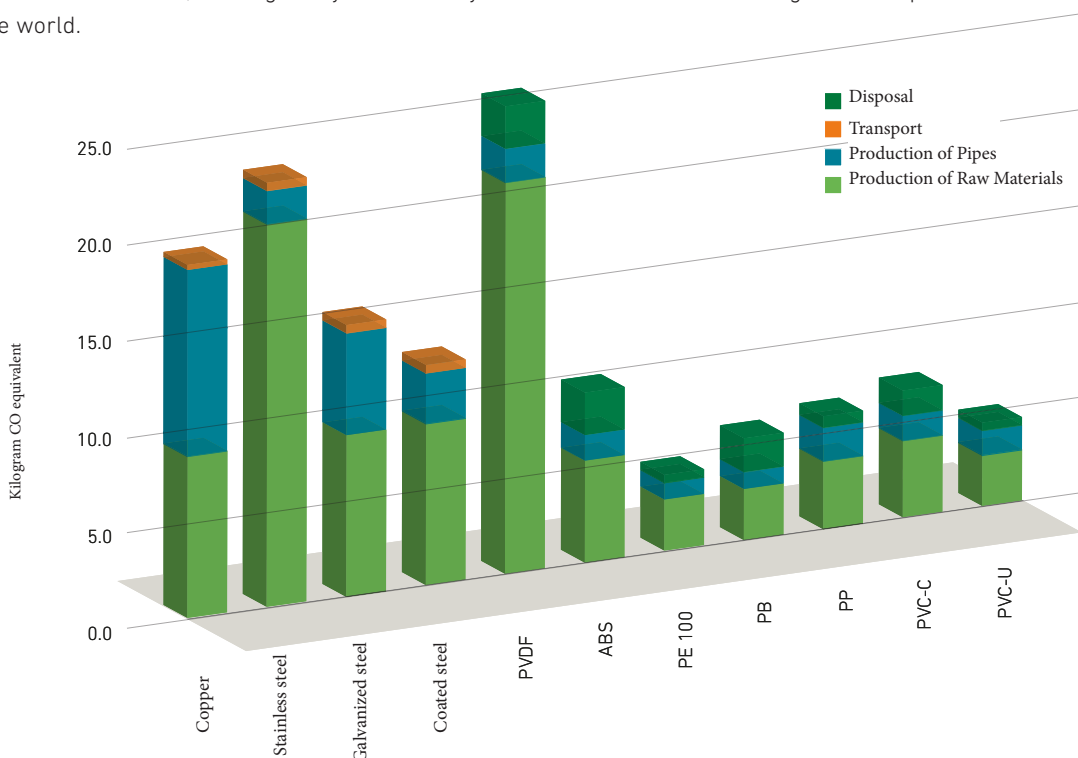

Quality Certificates

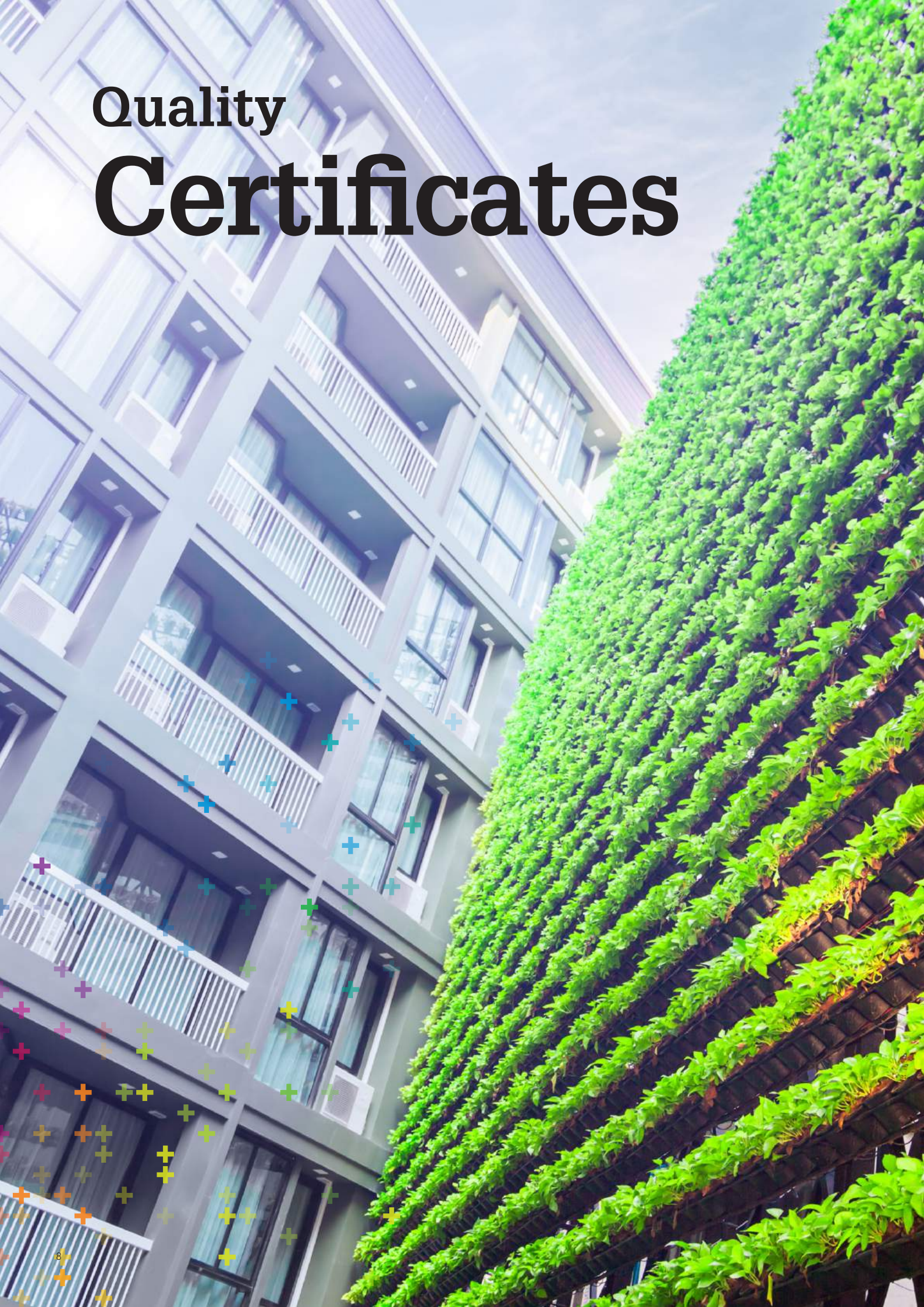

Manufacturing its products in accordance with the European standards and Turkish standards equivalent to the European standards, our Company is a leading and dynamic organization in terms of continuous improvement and customer satisfaction.

Some of the product quality certificates of our Company are as follows:

DVGW (Germany) - SKZ (Germany) - Hygiene Institute (Germany) - Fraunhofer (Germany) - Nordic Polymark (Sweden) - AENOR (Spain) - UkrSepro (Ukraine) - GOST (Russia) - SABS (South Africa) - TSE (Turkey)

Presenting its product standards in a way that offers the quality and continuity required for customers, GF Hakan Plastik exports its products to over 70 countries based on these certificates.

In addition to product quality, the process and system quality of GF Hakan Plastik is certified by BVQI through TS EN ISO 9001:2015 certificate and the company maintains its efforts on certification. Our Company that places top priority on process and system quality also has TS EN ISO 14001:2015 and TS EN ISO 45001:2018 certificates. Our both two production plants in Çerkezköy and Şanlıurfa have TS EN ISO/IEC 17025:2017 laboratory accreditation certificates awarded by TÜRKAK organization.

Certificates

 TURKEY- TSE	 SCANDINAVIAN COUNTRIES SWEDCERT	 TURKEY TÜRKAK	 RUSSIA-BELARUS UKRAINE GOST-r
 SPAIN AFITI LICOF	 GERMANY DIN CERTCO	 SWITZERLAND SGS	 RUSSIA-BELARUS KAZAKHSTAN-KYRYGYZSTAN ARMENIA
 UKRAINE UKR - SEPRO	 NETHERLANDS KIWA	 BULGARIA BULGARKONTROLA	 UK WRAS
 UKRAINE HYGIENE	 SCANDINAVIAN COUNTRIES SWEDCERT KIWA	 HUNGARY HUNGARY - EMI	 RUSSIA HYGIENE
 BUREAU VERITAS	 SOUTH AFRICA SABS	 GERMANY- RUSSIA HYGIENE INSTITUT	 GERMANY HOCH
 SOUTH AFRICA SANAS	 UK LLOYD'S REGISTER	 TURKEY EUROGAP	 BULGARIA NJN
 TURKEY YILDIZ TECHNICAL UNIVERSITY REPORT	 MALAYSIA IKRAM QA	 GERMANY DVGW	 GERMANY DIBT
 UNITED STATES OF AMERICA NSF	 GERMANY FRAUNHOFER INSTITUTE	 SPAIN AENOR	 STN TC

GF Aquasystem PP-R and PP-RCT Piping Systems

Aquasystem PP-R Piping Systems is a lightweight piping system made of PP-R copolymer material, with high mechanical strength and resistance to corrosion.

- Provides high resistance to extreme temperatures and pressure. PP-R pipes and fittings are produced in accordance with TS EN 15874-1, TS EN 15874-2, TS EN 15874-3, DIN 8077, DIN 8078, TS 13715, DIN 18836 standards.
 - Pipes and fittings available in the diameter range of d20-d200.
 - High chemical resistance, no corrosion.
 - Fast, easy and practical installation by using socket, butt and electrofusion welding.
 - White, grey and green options available.
 - Hygienic and environmentally-friendly.
- GF Aquasystem PP-R Piping Systems are produced in 6 different types depending upon the areas of use and customer expectations:
 - PP-R Standard Piping Systems (PN10-PN16-PN20)
 - PP-R Glass Fiber Reinforced Piping Systems (PN20-PN25)
 - PP-R Glass Fiber Reinforced Climafaser Piping Systems (PN10)
 - PP-R Stable External Aluminum Foil Piping Systems (PN25)
 - PP-R Aluplus Stable Middle Foil Piping Systems (PN20)
 - PP-R UV-Resistant Piping Systems (PN20-PN25)

PP-RCT is a new generation raw material which is developed for polypropylene by using a special β -nucleation process.

Thanks to this enhancement, GF Aquasystem withstand higher operating pressures at extreme temperatures, higher flow rates and resistance to chlorine.

- PP-RCT Glass-Fiber Reinforced Piping Systems :
 - SDR9 - PN22
 - SDR7,4 - PN25

+ Fields of Application

- Central heating systems
- Hot and cold water systems
- Drinking water and treated water supply systems
- Industrial Piping Systems (Transfer and discharge of chemicals)
- Air conditioner systems
- Solar Collectors



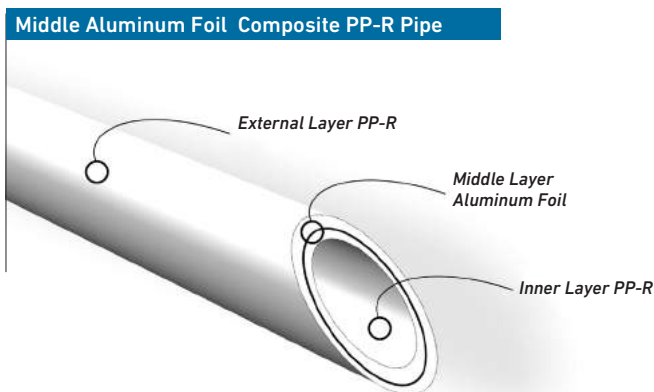
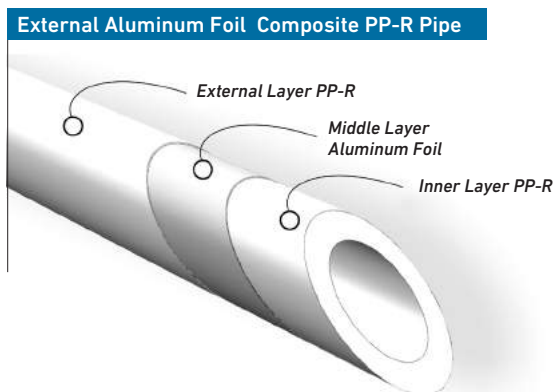
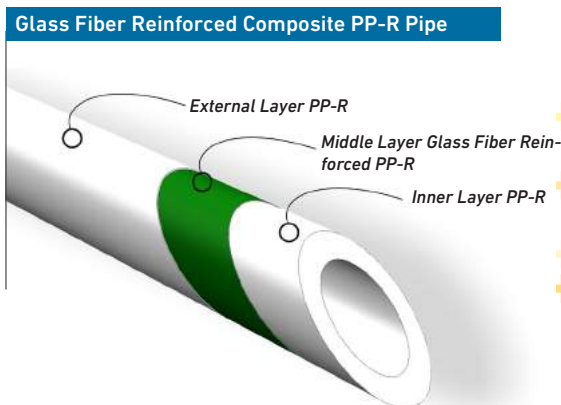
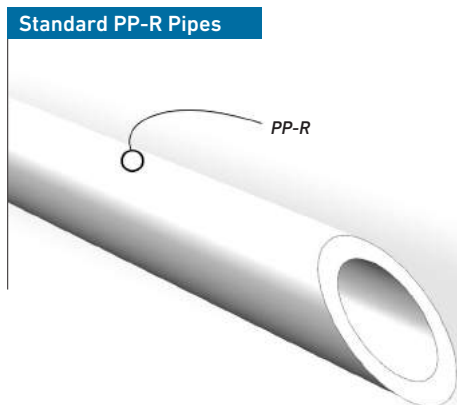

+ Technical Properties

Pipe Structure	One Layer-Standard Pipes Multi-Layer: Glass Fiber Reinforced Composite Pipes/Aluminum Foil Composite Pipes
Diameters [mm]	d20, d25, d32, d40, d50, d63, d75, d90, d110, d125, d160, d200
Pressure Classes:	Standard PPR Pipes PN10 (SDR11), PN16 (SDR7.4), PN20 (SDR6) Glass Fiber Reinforced Composite Pipes: PN10 (SDR11), PN20 (SDR7.4), PN25 (SDR6) External Aluminum Foil Composite Pipes: PN25 (SDR6) Middle Aluminum Foil Composite Pipes: PN20 (SDR6) PP-RCT Glass Fiber Reinforced Pipes (SDR9: PN22 – SDR7,4; PN25)
Pipe Length [mm]	4000 mm
Joining Methods	Socket Fusion Welding, Butt-Welding, Electrofusion Welding, Mechanical Connection, Flange Connection
Color	White, Green, Grey (For grey colour codes, please contact to GF Hakan Sales Department)
Chemical Resistance	Resistant to organic and inorganic chemical environments for pH values between 2 and 12
Installation Temperature	Minimum: +5°C Maximum: +40°C
Operating Temperature	Standard PPR Pipes: +5°C - +70°C Glass Fiber Reinforced Composite Pipes: +5°C - +95°C Aluminum Foil Composite Pipes: +5°C - +95°C
Application Class	B (Building)
Standards	EN15874-1/2/3, DIN 8077-78
Thermal Expansion Coefficient	Standard Pipes: 0.15 mm/m°K Glass Fiber Reinforced Composite Pipes: 0.035 mm/m°K Aluminum Foil Composite Pipes: 0.030 mm/m°K
Thermal Conductivity Coefficient	0.24 W/m°K
Approvals and Certificates	Spain: AENOR, UK: WRAS, LLYOD's, Germany: DVGW, SKZ, HYGIENE, Turkey: TSE, Ukraine: HYGIENE, SEPRO, Russia: GOST, HYGIENE, Bulgaria: BULGARKONTROLA

PP-R Aquasystem

PP-R Standard Pipe - PN10 (SDR11)



Dia. (mm)	Thic. (mm)	Code - White	Code - Green	Packing	
				Type	Pc
20	1,9	4000002002021	4002002002021	Bundle	100
25	2,3	4000002502121	4002002502121	Bundle	80
32	2,9	4000003202221	4002003202221	Bundle	60
40	3,7	4000004002321	4002004002321	Bundle	40
50	4,6	4000005002421	4002005002421	Bundle	20
63	5,8	4000006302521	4002006302521	Bundle	16
75	6,8	4000007502621	4002007502621	Bundle	12
90	8,2	4000009002721	4002009002721	Bundle	8
110	10,0	4000011002821	4002011002821	Bundle	4
125	11,4	4000012502921	4002012502921	Bundle	4
160	14,6	4000016000821	4002016000821	Bundle	4
200	18,2	4000020000121	4002020000121	Bundle	4

PP-R Glass Fiber Reinforced Climafaser Pipe - PN10 (SDR 11)



Dia. (mm)	Thic. (mm)	Code - Green	Packing	
			Type	Pc
20 *	2,8	4202002030021	Bundle	100
25 *	3,5	4202002530021	Bundle	80
32	2,9	4202003230121	Bundle	60
40	3,7	4202004030021	Bundle	40
50	4,6	4202005030021	Bundle	20
63	5,8	4202006330121	Bundle	16
75	6,8	4202007530021	Bundle	12
90	8,2	4202009030021	Bundle	8
110	10,0	4202011030021	Bundle	4
125	11,4	4202012530021	Bundle	4

*For d20 and d25 diameter products, SDR7.4 (PN20) Glass Fiber Reinforced Composite Pipes are suggested.

Note: Our climafaser pipes are green.

PP-R Standard Pipe - PN16 (SDR7,4)



Dia. (mm)	Thic. (mm)	Code - White	Code - Green	Packing	
				Type	Pc
20	2,8	4000002004021	4000002004021	Bundle	100
25	3,5	4000002504121	4000002504121	Bundle	80
32	4,4	4000003204221	4000003204221	Bundle	60
40	5,5	4000004004321	4000004004321	Bundle	40
50	6,9	4000005004421	4000005004421	Bundle	20
63	8,6	4000006304521	4000006304521	Bundle	16
75	10,3	4000007504621	4000007504621	Bundle	12
90	12,3	4000009004721	4000009004721	Bundle	8
110	15,1	4000011004821	4000011004821	Bundle	4
125	17,1	4000012504821	4000012504821	Bundle	4
160	21,9	4000016000921	4000016000921	Bundle	4
200	27,4	4000020001121	4000020001121	Bundle	4

PP-R Glass Fiber Reinforced Pipe - PN20 (SDR7,4)



Dia. (mm)	Thic. (mm)	Code - White	Code - Green	Packing	
				Type	Pc
20	2,8	4200002000121	4202002000121	Bundle	100
25	3,5	4200002500221	4202002500221	Bundle	80
32	4,4	4200003200321	4202003200321	Bundle	60
40	5,5	4200004000421	4202004000421	Bundle	40
50	6,9	4200005000521	4202005000521	Bundle	20
63	8,6	4200006300621	4202006300621	Bundle	16
75	10,3	4200007500721	4202007500721	Bundle	12
90	12,3	4200009000821	4202009000821	Bundle	8
110	15,1	4200011000921	4202011000921	Bundle	4
125	17,1	4200012500121	4202012500121	Bundle	4
160	21,7	4200016000121	4202016000121	Bundle	4

PP-R Standard Pipe - PN20 (SDR6)



Dia. (mm)	Thic. (mm)	Code - White	Code - Green	Packing	
				Type	Pc
20	3,4	4000002000121	4002002000121	Bundle	100
25	4,2	4000002500221	4002002500221	Bundle	80
32	5,4	4000003200321	4002003200321	Bundle	60
40	6,7	4000004000421	4002004000421	Bundle	40
50	8,3	4000005000521	4002005000521	Bundle	20
63	10,5	4000006300621	4002006300621	Bundle	16
75	12,5	4000007500721	4002007500721	Bundle	12
90	15,0	4000009000821	4002009000821	Bundle	8
110	18,3	4000011000921	4002011000921	Bundle	4
125	20,8	4000012501021	4002012501021	Bundle	4
160	26,6	4000016001021	4002016001021	Bundle	4
200	33,2	4000020000221	4002020000221	Bundle	4

PP-R Glass Fiber Reinforced Pipe - PN25 (SDR6)



Dia. (mm)	Thic. (mm)	Code - White	Code - Green	Packing	
				Type	Pc
20	3,4	4200002002021	4202002002021	Bundle	100
25	4,2	4200002502121	4202002502121	Bundle	80
32	5,4	4200003202221	4202003202221	Bundle	60
40	6,7	4200004002321	4202004002321	Bundle	40
50	8,3	4200005002421	4202005002421	Bundle	20
63	10,5	4200006302521	4202006302521	Bundle	16
75	12,5	4200007506521	4202007506521	Bundle	12
90	15,0	4200009006621	4202009006621	Bundle	8
110	18,3	4200011006421	4202011006421	Bundle	4
125	20,8	4200012500221	4202012500221	Bundle	4
160	26,6	4200016000221	4202016000221	Bundle	4

PP-R Aquasystem

PP-R Middle Aluminum Foiled Pipe- PN20 (SDR6)



Dia. (mm)	Thic. (mm)	Code - White	Code - Green	Packing Type	Pc
20	3,4	4100002010021	4102002010021	Bundle	100
25	4,2	4100002510021	4102002510021	Bundle	80
32	5,4	4100003210021	4102003210021	Bundle	40
40	6,7	4100004010021	4102004010021	Bundle	40
50	8,3	4100005010021	4102005010021	Bundle	20
63	10,5	4100006310021	4102006310021	Bundle	16

PP-R UV Resistant Standard Pipe - PN20 (SDR6)



Dia. (mm)	Thic. (mm)	Code - White	Code - Green	Packing Type	Pc
20	3,4	4000002010021	4002002010021	Bundle	100
25	4,2	4000002510021	4002002510021	Bundle	80
32	5,4	4000003210021	4002003210021	Bundle	60
40	6,7	4000004010021	4002004010021	Bundle	40
50	8,3	4000005010021	4002005010021	Bundle	20
63	10,5	4000006310021	4002006310021	Bundle	16

PP-R External Aluminum Foiled Pipe - PN25 (SDR6)



Dia. (mm)	Thic. (mm)	Code - White	Code - Green	Packing Type	Pc
20	4,5	4100002010021	4102002010021	Bundle	100
25	5,3	4100002510021	4102002510021	Bundle	80
32	6,5	4100003210021	4102003210021	Bundle	40
40	7,8	4100004010021	4102004010021	Bundle	40
50	9,4	4100005010021	4102005010021	Bundle	20
63	11,6	4100006310021	4102006310021	Bundle	16
75	13,6	4100007500721	4102007500721	Bundle	12
90	16,1	4100009000821	4102009000821	Bundle	8
110	19,4	4100011000921	4102011007421	Bundle	4

PP-R UV Resistant External Aluminum Foiled Pipe - PN25 (SDR6)



Dia. (mm)	Thic. (mm)	Code - White	Code - Green	Packing Type	Pc
20	4,5	4100002000121	4102002000121	Bundle	100
25	5,3	4100002500221	4102002500221	Bundle	80
32	6,5	4100003200321	4102003200321	Bundle	40
40	7,8	4100004000421	4102004000421	Bundle	40
50	9,4	4100005000521	4102005000521	Bundle	20
63	11,6	4100006300621	4102006300621	Bundle	16

Aquasystem® PP-RCT Faser Fiberglass Reinforced Pipe SDR7.4 - PN25



Dia. (mm)	Thic. (mm)	Code - Green	Packing Type	Pc
20	2.8	4202002050021	Bundle	100
25	3.5	4202002550021	Bundle	80
32	4.4	4202003250021	Bundle	60
40	5.5	4202004050021	Bundle	40
50	6.9	4202005050021	Bundle	20
63	8.6	4202006350021	Bundle	16
75	10.3	4202007550021	Bundle	12
90	12.3	4202009050021	Bundle	8
110	15.1	4202011050021	Bundle	4
125	17.1	4202012550021	Bundle	4
160	21.7	4202016050021	Bundle	4

Aquasystem® PP-RCT Faser Fiberglass Reinforced Pipe SDR9 - PN22



Dia. (mm)	Thic. (mm)	Code - Green	Packing Type	Pc
20	2.3	4202002050121	Bundle	100
25	2.8	4202002550121	Bundle	80
32	3.6	4202003250121	Bundle	60
40	4.5	4202004050121	Bundle	40
50	5.6	4202005050121	Bundle	20
63	7.1	4202006350121	Bundle	16
75	8.4	4202007550121	Bundle	12
90	10.1	4202009050121	Bundle	8
110	12.3	4202011050121	Bundle	4
125	14.0	4202012550121	Bundle	4
160	17.9	4202016050121	Bundle	4

PP-R Aquasystem

PP-R Elbow 90°



Dia. (mm)	Code - White	Code - Green	Packing	
			Type	Pc
20	4300102000721	4302102000721	Cartonbox	400
25	4300102500821	4302102500821	Cartonbox	250
32	4300103200921	4302103200921	Cartonbox	125
40	4300104001021	4302104001021	Cartonbox	75
50	4300105001121	4302105001121	Cartonbox	40
63	4300106301221	4302106301221	Cartonbox	20
75	4300107501321	4302107501321	Cartonbox	16
90	4300109001421	4302109001421	Cartonbox	8
110	4300111001521	4302111001521	Cartonbox	3
125	4300112501622	4302112501622	Cartonbox	2
160	4300116001421	4302116001421	Cartonbox	2

For butt fusion type, please contact with Product Manager

PP-R Socket



Dia. (mm)	Code - White	Code - Green	Packing	
			Type	Pc
20	4300502020021	4302502020021	Cartonbox	500
25	4300502520121	4302502520121	Cartonbox	350
32	4300503220221	4302503220221	Cartonbox	200
40	4300504020321	4302504020321	Cartonbox	125
50	4300505020421	4302505020421	Cartonbox	30
63	4300506320521	4302506320521	Cartonbox	18
75	4300507520621	4302507520621	Cartonbox	10
90	4300509020721	4302509020721	Cartonbox	8
110	4300511020821	4302511020821	Cartonbox	4
125	4300512520922	4302512520921	Cartonbox	7
160	4300516000121	4302516000121	Cartonbox	4

PP-R Elbow 45°



Dia. (mm)	Code - White	Code - Green	Packing	
			Type	Pc
20	4300102000121	4302102000121	Cartonbox	400
15	4300102500221	4302102500221	Cartonbox	250
32	4300103200321	4302103200321	Cartonbox	125
40	4300104000421	4302104000421	Cartonbox	75
50	4300105000521	4302105000521	Cartonbox	40
63	4300106300621	4302106300621	Cartonbox	20
75	4300107501221	4302107501221	Cartonbox	4
90	4300109001322	4302109001322	Cartonbox	3
110	4300111001422	4302111001422	Cartonbox	3
125	4300112501522	4302112501522	Cartonbox	2
160	4300116001621	4302116001621	Cartonbox	2

For butt fusion type, please contact with Product Manager

Reducer PP-R



Dia. (mm)	Code - White	Code - Green	Packing	
			Type	Pc
25-20	4300402510021	4302402510021	Cartonbox	500
32-20	4300403210121	4302403210121	Cartonbox	200
32-25	4300403210221	4302403210221	Cartonbox	150
40-20	4300404010321	4302404010321	Cartonbox	100
40-25	4300404010421	4302404010421	Cartonbox	100
40-32	4300404010521	4302404010521	Cartonbox	75
50-20	4300405010621	4302405010621	Cartonbox	75
50-25	4300405010721	4302405010721	Cartonbox	50
50-32	4300405010821	4302405010821	Cartonbox	75
50-40	4300405010921	4302405010921	Cartonbox	40
63-25	4300406311021	4302406311021	Cartonbox	30
63-32	4300406311121	4302406311121	Cartonbox	30
63-40	4300406311221	4302406311221	Cartonbox	30
63-50	4300406311321	4302406311321	Cartonbox	20
75-50	4300407511421	4302407511421	Cartonbox	16
75-63	4300407511521	4302407511521	Cartonbox	16
90-50	4300409011521	4302409011521	Cartonbox	10
90-63	4300409011621	4302409011621	Cartonbox	20
90-75	4300409011721	4302409011721	Cartonbox	4
110-63	4300411011721	4302411011721	Cartonbox	16
110-75	4300411011821	4302411011821	Cartonbox	8
110-90	4300411011921	4302411011921	Cartonbox	16
125-75	4300412512022	4302412512022	Cartonbox	5
125-90	4300412512122	4302412512122	Cartonbox	7
125-110	4300412512222	4302412512222	Cartonbox	5
160-110	4300416011921	4302416011921	Cartonbox	1

PP-R Male to Female Elbow 90°



Dia. (mm)	Code - White	Code - Green	Packing	
			Type	Pc
20	4300102005021	4302102005021	Cartonbox	100
25	4300102505121	4302102505121	Cartonbox	80

PP-R Reducing Elbow



Dia. (mm)	Code - White	Code - Green	Packing	
			Type	Pc
20-25	4300402011021	4302402011021	Cartonbox	100
25-32	4300402511121	4302402511121	Cartonbox	75

PP-R Aquasystem

PP-R Tee



Dia. (mm)	Code - White	Code - Green	Packing	
			Type	Pc
20	4300902008021	4302902008021	Cartonbox	250
25	4300902508121	4302902508121	Cartonbox	150
32	4300903208221	4302903208221	Cartonbox	100
40	4300904008321	4302904008321	Cartonbox	20
50	4300905008421	4302905008421	Cartonbox	30
63	4300906308521	4302906308521	Cartonbox	8
75	4300907508621	4302907508621	Cartonbox	4
90	4300909008721	4302909008721	Cartonbox	2
110	4300911008821	4302911008821	Cartonbox	3
125	4300912508922	4302912508922	Cartonbox	2
160	4300916009021	4302916009021	Cartonbox	1

For butt fusion type, please contact with Product Manager

PP-R End Cap



Dia. (mm)	Code	Packing	
		Type	Pc
20	4300902006021	Cartonbox	500
25	4300902506121	Cartonbox	300
32	4300903206221	Cartonbox	100
40	4300904006321	Cartonbox	75
50	4300905006421	Cartonbox	40
63	4300906306521	Cartonbox	20
75	4300907506621	Cartonbox	25
90	4300909006821	Cartonbox	18
110	4300911006721	Cartonbox	3

PP-R Blind Cap



Dia. (mm)	Code - White	Code - Green	Packing	
			Type	Pc
20	4300902014021	4302902014021	Cartonbox	700
25	4300902514121	4302902514121	Cartonbox	300

PP-R Reducing Tee



Dia. (mm)	Code - White	Code - Green	Packing	
			Type	Pc
25-20-20	4300902520021	4302902520021	Cartonbox	100
25-20-25	4300902520121	4302902520121	Cartonbox	175
32-20-20	4300903220221	4302903220221	Cartonbox	50
32-20-25	4300903220321	4302903220321	Cartonbox	50
32-20-32	4300903220421	4302903220421	Cartonbox	100
32-25-20	4300903220521	4302903220521	Cartonbox	50
32-25-32	4300903220621	4302903220621	Cartonbox	100
40-20-40	4300904020721	4302904020721	Cartonbox	25
40-25-40	4300904020821	4302904020821	Cartonbox	50
40-32-40	4300904020921	4302904020921	Cartonbox	20
50-20-50	4300905021021	4302905021021	Cartonbox	10
50-25-50	4300905021221	4302905021221	Cartonbox	10
50-32-50	4300905021321	4302905021321	Cartonbox	10
50-40-50	4300905021421	4302905021421	Cartonbox	30
63-20-63	4300906321321	4302906321321	Cartonbox	24
63-25-63	4300906321421	4302906321421	Cartonbox	12
63-32-63	4300906321521	4302906321521	Cartonbox	8
63-40-63	4300906321621	4302906321621	Cartonbox	16
63-50-63	4300906321721	4302906321721	Cartonbox	10
75-63-75	4300907521722	4302907521722	Cartonbox	10
75-32-75	4300907521822	4302907521822	Cartonbox	10
75-40-75	4300907521922	4302907521922	Cartonbox	10
90-63-90	4300909021622	4302909021622	Cartonbox	6
90-75-90	4300909021722	4302909021722	Cartonbox	2
110-63-110	4300911021522	4302911021522	Cartonbox	2
110-75-110	4300911021622	4302911021622	Cartonbox	2

PP-R Crossover w Socket Short



Dia. (mm)	Code - White	Code - Green	Packing	
			Type	Pc
20	4300902000321	4302902000321	Cartonbox	100
25	4300902500321	4302902500321	Cartonbox	125

PP-R Crossover w Socket



Dia. (mm)	Code - White	Code - Green	Packing	
			Type	Pc
20	4300902000121	4302902000121	Cartonbox	120
25	4300902500221	4302902500221	Cartonbox	80
32	4300903200321	4302903200321	Cartonbox	30

PP-R Cross



Dia. (mm)	Code - White	Code - Green	Packing	
			Type	Pc
20	4300902060022	4302902060022	Cartonbox	100
25	4300902560122	4302902560122	Cartonbox	50
32	4300903260222	4302903260222	Cartonbox	30
40	4300904060322	4302904060322	Cartonbox	40

PP-R Aquasystem

PP-R Reducing Cross



Dia. (mm)	Code - White	Code - Green	Packing	
			Type	Pc
25-20	4300902560222	-	Cartonbox	150
32-25	4300903260322	4302903260322	Cartonbox	75
40-32	4300904060422	4302904060422	Cartonbox	40

PP-R Omega



Dia. (mm)	Code	Packing	
		Type	Pc
20	4300902007022	Cartonbox	15
25	4300902507122	Cartonbox	10
32	4300903207222	Cartonbox	7
40	4300904007322	Cartonbox	5

PP-R Saddle w Spigot Female - (G-Type)



Dia. (mm)	Code - Green	Packing	
		Type	Pc
40 - 20	4302904090022	Cartonbox	50
40 - 25	4302904090122	Cartonbox	50
50 - 20	4302905090022	Cartonbox	50
50 - 25	4302905090122	Cartonbox	50
63 - 20	4302906390022	Cartonbox	50
63 - 25	4302906390122	Cartonbox	50
63 - 32	4302906390222	Cartonbox	25
75 - 20	4302907590022	Cartonbox	50
75 - 25	4302907590122	Cartonbox	50
75 - 32	4302907590222	Cartonbox	25
75 - 40	4302907590322	Cartonbox	25
90 - 20	4302909090022	Cartonbox	50
90 - 25	4302909090122	Cartonbox	50
90 - 32	4302909090222	Cartonbox	25
90 - 40	4302909090322	Cartonbox	25
110 - 20	4302911090022	Cartonbox	50
110 - 25	4302911090122	Cartonbox	50
110 - 32	4302911090222	Cartonbox	24
110 - 40	4302911090322	Cartonbox	25
125 - 20	4302912590022	Cartonbox	50
125 - 25	4302912590122	Cartonbox	50
125 - 32	4302912590222	Cartonbox	25
125 - 40	4302912590322	Cartonbox	25
110 - 50	4302911090422	Cartonbox	24
125 - 63	4302912590422	Cartonbox	18

PP-R Pipe Clamp Single



Dia. (mm)	Code - White	Code - Green	Packing	
			Type	Pc
20	4300902025021	4302902025021	Cartonbox	500
25	4300902525121	4302902525121	Cartonbox	300
32	4300903225221	4302903225221	Cartonbox	500
40	4300904025322	4302904025322	Cartonbox	300
50	4300905025422	4302905025422	Cartonbox	25
63	4300906331622	4302906331622	Cartonbox	300
75	4300907532022	4302907532022	Cartonbox	200
90	4300909032022	4302909032022	Cartonbox	100
110	4300911009022	4302911009022	Cartonbox	150

Pipe Double Clamp



Dia. (mm)	Code - White	Code - Green	Packing	
			Type	Pc
20	4300902025521	4302902025521	Cartonbox	200
25	4300902525621	4302902525621	Cartonbox	250
32	4300903225722	4302903225722	Cartonbox	200

Flange Adapter



Dia. (mm)	Code - Green	Packing	
		Type	Pc
25	4302902533022	Cartonbox	50
32	4302903233022	Cartonbox	50
40	4302904033022	Cartonbox	50
50	4302905033022	Cartonbox	20
63	4302906333022	Cartonbox	10
75	4302907533022	Cartonbox	4
90	4302909033022	Cartonbox	4
110	4302911033022	Cartonbox	3
125	4302912533022	Cartonbox	1
160	4302916033022	Cartonbox	1

PP-R Male Coupler (Round) - (G-Type)



Dia. (mm)	Code - White	Code - Green	Packing	
			Type	Pc
20-1/2"	4300702032021	4302702032021	Cartonbox	250
20-3/4"	4300702032121	4302702032121	Cartonbox	50
25-1/2"	4300702532221	4302702532221	Cartonbox	200
25-3/4"	4300702532321	4302702532321	Cartonbox	200
32-3/4"	4300703227321	4302703227321	Cartonbox	100
32-1"	4300703232421	4302703232421	Cartonbox	100

PP-R Aquasystem



PP-R Male Coupler (Round) - (BSPT-R)

Dia. (mm)	Code - Green	Packing	
		Type	Pc
20-1/2"	4302702040221	Cartonbox	250
20-3/4"	4302702040321	Cartonbox	200
25-1/2"	4302702540221	Cartonbox	200
25-3/4"	4302702540321	Cartonbox	200
32-3/4"	4302703240121	Cartonbox	100
32-1"	4302703240321	Cartonbox	100



PP-R Male Coupler (Hexagonal) - (BSPT-R)

Dia. (mm)	Code - Green	Packing	
		Type	Pc
32-1"	4302703230321	Cartonbox	80
40-1.1/4"	4302704040121	Cartonbox	50
50-1.1/2"	4302705040121	Cartonbox	40
63-2"	4302706340121	Cartonbox	20
75-2.1/2"	4302707527621	Cartonbox	16
90-3"	4302709029621	Cartonbox	10
110-4"	4302711027821	Cartonbox	4



PP-R Female Coupler (Round) - (G-Type)

Dia. (mm)	Code - White	Code - Green	Packing	
			Type	Pc
20-1/2"	4300702030021	4302702030021	Cartonbox	325
20-3/4"	4300702030121	4302702030121	Cartonbox	250
25-1/2"	4300702530221	4302702530221	Cartonbox	225
25-3/4"	4300702530321	4302702530321	Cartonbox	225
32-1"	4300703230421	4302703230421	Cartonbox	125
32-3/4"	4300703225321	4302703225321	Cartonbox	100



PP-R Female Coupler (Hexagonal) (G-Type)

Dia. (mm)	Code - White	Code - Green	Packing	
			Type	Pc
32-1"	4300703225021	4302703225021	Cartonbox	40
40-1.1/4"	4300704025121	4302704025121	Cartonbox	30
50-1.1/2"	4300705025221	4302705025221	Cartonbox	10
63-2"	4300706325321	4302706325321	Cartonbox	5
75-2.1/2"	4300707525421	4302707525421	Cartonbox	16
90-3"	4300709025621	4302709025621	Cartonbox	10
110-4"	4300711025521	4302711025521	Cartonbox	3



PP-R Female Coupler (Round) - (BSPT-Rp)

Dia. (mm)	Code - Green	Packing	
		Type	Pc
20-1/2"	4302702040021	Cartonbox	325
20-3/4"	4302702040121	Cartonbox	250
25-1/2"	4302702540021	Cartonbox	225
25-3/4"	4302702540121	Cartonbox	225
32-3/4"	4302703240021	Cartonbox	100
32-1"	4302703240221	Cartonbox	125



PP-R Female Coupler (Hexagonal) - (BSPT-Rp)

Dia. (mm)	Code - Green	Packing	
		Type	Pc
32-1"	4302703230621	Cartonbox	80
40-1.1/4"	4302704040021	Cartonbox	50
50-1.1/2"	4302705040021	Cartonbox	40
63-2"	4302706340021	Cartonbox	20
75-2.1/2"	4302707525621	Cartonbox	16
90-3"	4302709028621	Cartonbox	10
110-4"	4302711025721	Cartonbox	4



PP-R Male Coupler (Hexagonal) - (G-Type)

Dia. (mm)	Code - White	Code - Green	Packing	
			Type	Pc
32-1"	4300703227021	4302703227021	Cartonbox	40
40-1.1/4"	4300704027121	4302704027121	Cartonbox	50
50-1.1/2"	4300705027221	4302705027221	Cartonbox	20
63-2"	4300706327321	4302706327321	Cartonbox	20
75-2.1/2"	4300707527421	4302707527421	Cartonbox	16
90-3"	4300709027521	4302709027521	Cartonbox	4
110-4"	4300711027621	4302711027621	Cartonbox	4



PP-R Male Elbow (G-Type)

Dia. (mm)	Code - White	Code - Green	Packing	
			Type	Pc
20-1/2"	4300102007021	4302102007021	Cartonbox	200
20-3/4"	4300102007121	4302102007121	Cartonbox	200
25-1/2"	4300102507221	4302102507221	Cartonbox	180
25-3/4"	4300102507321	4302102507321	Cartonbox	100
32-3/4"	4300103207421	4302103207421	Cartonbox	75
32-1"	4300103207521	4302103207521	Cartonbox	80

PP-R Aquasystem

PP-R Male Elbow (BSPT-R)



Dia. (mm)	Code - Green	Packing	
		Type	Pc
20-1/2"	4302102030221	Cartonbox	200
20-3/4"	4302102030321	Cartonbox	180
25-1/2"	4302102530221	Cartonbox	180
25-3/4"	4302102530321	Cartonbox	100
32-3/4"	4302103230221	Cartonbox	75
32-1"	4302103230321	Cartonbox	80

PP-R Female Tee - (G-Type)



Dia. (mm)	Code - White	Code - Green	Packing	
			Type	Pc
20-1/2"	4300902010021	4302902010021	Cartonbox	160
20-3/4"	4300902010121	4302902010121	Cartonbox	80
25-1/2"	4300902510221	4302902510221	Cartonbox	120
25-3/4"	4300902510321	4302902510321	Cartonbox	60
32-3/4"	4300903210421	4302903210421	Cartonbox	30
32-1"	4300903210521	4302903210521	Cartonbox	30

PP-R Female Elbow (G-Type)



Dia. (mm)	Code - White	Code - Green	Packing	
			Type	Pc
20-1/2"	4300102006021	4302102006021	Cartonbox	200
20-3/4"	4300102006121	4302102006121	Cartonbox	80
25-1/2"	4300102506221	4302102506221	Cartonbox	175
25-3/4"	4300102506321	4302102506321	Cartonbox	140
32-3/4"	4300103206421	4302103206421	Cartonbox	30
32-1"	4300103206521	4302103206521	Cartonbox	30

PP-R Female Tee (BSPT-Rp)



Dia. (mm)	Code - Green	Packing	
		Type	Pc
20-1/2"	4302902030021	Cartonbox	160
20-3/4"	4302902030121	Cartonbox	160
25-1/2"	4302902530021	Cartonbox	120
25-3/4"	4302902530121	Cartonbox	120
32-3/4"	4302903230021	Cartonbox	60
32-1"	4302903230121	Cartonbox	70

PP-R Union Socket Female (G-Type)



Dia. (mm)	Code - White	Code - Green	Packing	
			Type	Pc
20-1/2"	4300902003021	4302702003021	Cartonbox	100
20-3/4"	4300902003121	4302902003121	Cartonbox	150
25-3/4"	4300902503321	4302702503121	Cartonbox	50
32-1"	4300903203521	4302703203521	Cartonbox	50
40-1.1/4"	4300904005021	4302904005021	Cartonbox	20
50-1.1/2"	4300905005121	4302905005121	Cartonbox	15
63-2"	4300906305221	4302906305221	Cartonbox	4

PP-R Female Elbow (BSPT-Rp)



Dia. (mm)	Code - Green	Packing	
		Type	Pc
20-1/2"	4302102030021	Cartonbox	200
20-3/4"	4302102030121	Cartonbox	200
25-1/2"	4302102530021	Cartonbox	175
25-3/4"	4302102530121	Cartonbox	140
32-3/4"	4302103230021	Cartonbox	75
32-1"	4302103230121	Cartonbox	75

PP-R Union Socket Female (BSPT-Rp)



Dia. (mm)	Code - Green	Packing	
		Type	Pc
20-1/2"	4302702030421	Cartonbox	300
20-3/4"	4302902030321	Cartonbox	150
25-3/4"	4302702530021	Cartonbox	150
32-1"	4302703230021	Cartonbox	150
40-1.1/4"	4302904030021	Cartonbox	50
50-1.1/2"	4302905030021	Cartonbox	30
63-2"	4302906330021	Cartonbox	20

PP-R Male Tee - (G-Type)



Dia. (mm)	Code - White	Code - Green	Packing	
			Type	Pc
20-1/2"	4300902012021	4302902004021	Cartonbox	60
20-1/2"	-	4302902030221	Cartonbox	-

PP-R Union Male Female (G-Type)



Dia. (mm)	Code - White	Code - Green	Packing	
			Type	Pc
20-1/2"	4300902004021	4302702004021	Cartonbox	150
20-3/4"	4300902004121	4302902004121	Cartonbox	50
25-3/4"	4300902504321	4302702504321	Cartonbox	150
32-1"	4300903204521	4302703204521	Cartonbox	50
40-1.1/4"	4300904005321	4302904005321	Cartonbox	20
50-1.1/2"	4300905005421	4302905005421	Cartonbox	15
63-2"	4300906305521	4302906305521	Cartonbox	10

PP-R Aquasystem



PP-R Union Socket Male (BSPT-R)

Dia. (mm)	Code - Green	Packing	
		Type	Pc
20-1/2"	4302702030521	Cartonbox	300
20-3/4"	4302902030421	Cartonbox	150
25-3/4"	4302702530121	Cartonbox	150
32-1"	4302703230121	Cartonbox	125
40-1.1/4"	4302904030121	Cartonbox	50
50-1.1/2"	4302904030121	Cartonbox	30
63-2"	4302904030121	Cartonbox	20



PP-R Backplate Elbow Double Female (G-Type)

Dia. (mm)	Code - White	Code - Green	Packing	
			Type	Pc
25-1/2"	4300902502121	4302902502121	Cartonbox	40

Transition w Loose Nut



Dia. (mm)	Code - White	Code - Green	Packing	
			Type	Pc
20-1/2"	4300902013021	4302902013021	Cartonbox	100
20-3/4"	4300902513221	4302902513221	Cartonbox	100
25-1"	4300902513321	4302902513321	Cartonbox	50



PP-R Backplate Elbow Male (G-Type)

Dia. (mm)	Code - White	Code - Green	Packing	
			Type	Pc
20-1/2"	4300902002121	4302902002121	Cartonbox	150



PP-R Backplate Elbow Male (G-Type)

Dia. (mm)	Code - White	Code - Green	Packing	
			Type	Pc
25-3/4"	4300102509221	4302102509221	Cartonbox	100
25-3/4"	*	4302102530621	Cartonbox	100

Note: Please ask for Product Manager.



PP-R Faucet Connection- Bidet (G-Type)

Dia. (mm)	Code	Packing	
		Type	Pc
20-1/2"	4300902012121	Parcel	15



PP-R Distribution Manifold

Dia. (mm)	Code - White	Code - Green	Packing	
			Type	Pc
20-1/2"	4300902002321	4302902002321	Cartonbox	15



PP-R Backplate Elbow Female (G-Type)

Dia. (mm)	Code - White	Code - Green	Packing	
			Type	Pc
20-1/2"	4300902002021	4302902002021	Cartonbox	150
25-1/2"	4300102508221	4302102530421	Cartonbox	-
20-1/2"	-	4302902030721	Cartonbox	-
25-3/4"	-	4302102530621	Cartonbox	-
20-1/2"	-	4302902030621	Cartonbox	-

PP-R Backplate Elbow Female 2 Pins (G-Type)



Dia. (mm)	Code - White	Code - Green	Packing	
			Type	Pc
25-1/2"	4300902503121	4302902503121	Cartonbox	50
20-1/2"	4300902011021	4302902011021	Cartonbox	50



PP-R Backplate Elbow Female (G-Type)

Dia. (mm)	Code - White	Code - Green	Packing	
			Type	Pc
20-3/4"	4300102008121	4302102008121	Cartonbox	100
25-1/2"	4300102508221	4302102508221	Cartonbox	100
25-3/4"	4300102508321	4302102508321	Cartonbox	100



PP-R Double Male Faucet Connection (G-Type)

Dia. (mm)	Code	Packing	
		Type	Pc
25-1/2"	4300902502021	Parcel	40

PP-R Aquasystem



PP-R Saddle w Spigot Female

Dia. (mm)	Code - Green	Packing	
		Type	Pc
40-1/2"	4302904091122	Cartonbox	50
50-1/2"	4302905091122	Cartonbox	50
50-3/4"	4302905091022	Cartonbox	50
63-1/2"	4302906391122	Cartonbox	50
63-3/4"	4302906391022	Cartonbox	50
75-1/2"	4302907591122	Cartonbox	50
75-3/4"	4302907591022	Cartonbox	50
75-1"	4302907591222	Cartonbox	25
90-1/2"	4302909091122	Cartonbox	50
90-3/4"	4302909091022	Cartonbox	50
90-1"	4302909091222	Cartonbox	25
110-1/2"	4302911091122	Cartonbox	50
110-3/4"	4302911091022	Cartonbox	50
110-1"	4302911091222	Cartonbox	25
125-1/2"	4302912591122	Cartonbox	50
125-3/4"	4302912591022	Cartonbox	50
125-1"	4302912591222	Cartonbox	25

PP-R Electro Fusion Coupler



Dia. (mm)	Code - Green	Packing	
		Type	Pc
20	4302902091522	Cartonbox	150
25	4302902591522	Cartonbox	130
32	4302903291522	Cartonbox	80
40	4302904091522	Cartonbox	50
50	4302905091522	Cartonbox	30
63	4302906391522	Cartonbox	20
75	4302907591522	Cartonbox	14
90	4302909091522	Cartonbox	10
110	4302911091522	Cartonbox	3
125	4302912591522	Cartonbox	3
160	4302916091522	Cartonbox	2

PP-R Union – PN10



Dia. (mm)	Code - White	Code - Green	Packing	
			Type	Pc
20	4300902028021	4302902028021	Cartonbox	100
25	4300902528121	4302902528121	Cartonbox	50
32	4300903228221	4302903228221	Cartonbox	80
40	4300904028321	4302904028321	Cartonbox	20
50	4300905028421	4302905028421	Cartonbox	15
63	4300906328521	4302906328521	Cartonbox	20
75	4300907528621	4302907528621	Cartonbox	16
90	4300909032521	4302909032521	Cartonbox	8

Note: Only for cold water applications.

PP-R Check Valve – PN10



Dia. (mm)	Code - White	Code - Green	Packing	
			Type	Pc
20	4300902031022	4302902031022	Cartonbox	20
25	4300902531122	4302902531122	Cartonbox	50
32	4300903231222	4302903231222	Cartonbox	40
40	4300904031322	4302904031322	Cartonbox	24
50	4300905031422	4302905031422	Cartonbox	15
63	4300906331522	4302906331522	Cartonbox	8
75	4300907531622	4302907531622	Cartonbox	4
90	4300909031722	4302909031722	Cartonbox	2

Note: Only for cold water applications.

Union Ball Valve – PN10



Dia. (mm)	Code - White	Code - Green	Packing	
			Type	Pc
20	4300802042522	4302802042522	Cartonbox	70
25	4300802542622	4302802542622	Cartonbox	50
32	4300803242722	4302803242722	Cartonbox	30
40	4300804043122	4302804043122	Cartonbox	15
50	4300805043222	4302805043222	Cartonbox	12
63	4300806343322	4302806343322	Cartonbox	8

Note: Only for cold water applications.

Ball Valve New (Welt-In) - PN20



Dia. (mm)	Code - White	Code - Green	Packing	
			Type	Pc
20	4300802042822	4302802042822	Cartonbox	30
25	4300802542922	4302802542922	Cartonbox	30
32	4300803243022	4302803243022	Cartonbox	45
40	4300804043622	4302804043622	Cartonbox	10
50	4300805043722	4302805043722	Cartonbox	20
63	4300806343822	4302806343822	Cartonbox	3
75	4300807543322	4302807543322	Cartonbox	8

PP-R Gate Valve



Dia. (mm)	Code - White	Code - Green	Packing	
			Type	Pc
20-1/2"	4300802035021	4300802035021	Cartonbox	75
25-3/4"	4300802535121	4300802535121	Cartonbox	20
32-1"	4300803235221	4300803235221	Cartonbox	15

PP-R Aquasystem



PP-R Chromium Valve Short

Dia. (mm)	Code - White	Code - Green	Packing	
			Type	Pc
20-1/2"	4300802040021	4302802040021	Cartonbox	20
25-3/4"	4300802540221	4302802540221	Cartonbox	20
32-1"	4300803240421	4302803240421	Cartonbox	10



PP-R Pipe Sharpener Plastic

Dia. (mm)	Code - White	Packing	
		Type	Pc
20-25	4300902041022	Cartonbox	70
32-40	4300903241122	Cartonbox	50



PP-R Chromium Valve Long

Dia. (mm)	Code - White	Code - Green	Packing	
			Type	Pc
20-1/2"	4300802040121	4302802040121	Cartonbox	50
25-3/4"	4300802540321	4302802540321	Cartonbox	20
32-1"	4300803240521	4302803240521	Cartonbox	40



Welding Machine

Dia. (mm)	Code - White	Packing	
		Type	Pc
d20-d125	4301900045082	Metalbox	1
d20-d100	4301900044382	Cartonbox	1

Welding Machine



Dia. (mm)	Code - White	Packing	
		Type	Pc
75-100	4301900044382	Cartonbox	1



PP-R Lux Chromium Valve Long

Dia. (mm)	Code - White	Code - Green	Packing	
			Type	Pc
20-1/2"	4300802060721	4302802060721	Cartonbox	20
25-3/4"	4300802560821	4302802560821	Cartonbox	40
32-1"	4300803240621	4302803240621	Cartonbox	40



Welding Machine

Dia. (mm)	Code - White	Packing	
		Type	Pc
63-160	4301900045982	Cartonbox	1

PP-R Pipe Sharpener Metal



Dia. (mm)	Code - White	Packing	
		Type	Pc
20-25	4301902040082	Cartonbox	100
32-40	4301903240182	Cartonbox	50
50-63	4301905040282	Cartonbox	15
75-90	4301907540382	Cartonbox	8



PP-R Pipe Cutter

Dia. (mm)	Code - White	Packing	
		Type	Pc
-	4301900043082	Parcel	4

PP-R Boiler Set



Type	Code - White	Packing	
		Type	Pc
Round [Gate Straight]	4300900050022	Cartonbox	8
Corner [Gate Angled]	4300900050122	Cartonbox	8

PP-R Pipe Welding Mould



Dia. (mm)	Code - White	Packing	
		Type	Pc
20	4301902045082	Cartonbox	300
25	4301902545182	Cartonbox	15
32	4301903245282	Cartonbox	200
40	4301904045382	Cartonbox	40
50	4301905045482	Cartonbox	70
63	4301906345582	Cartonbox	45
75	4301907545682	Cartonbox	30
90	4301909045782	Cartonbox	5
110	4301911045882	Cartonbox	5
160	4301916046082	Cartonbox	-

Technical Tables

- Temperature, Pressure and Service Life Tables

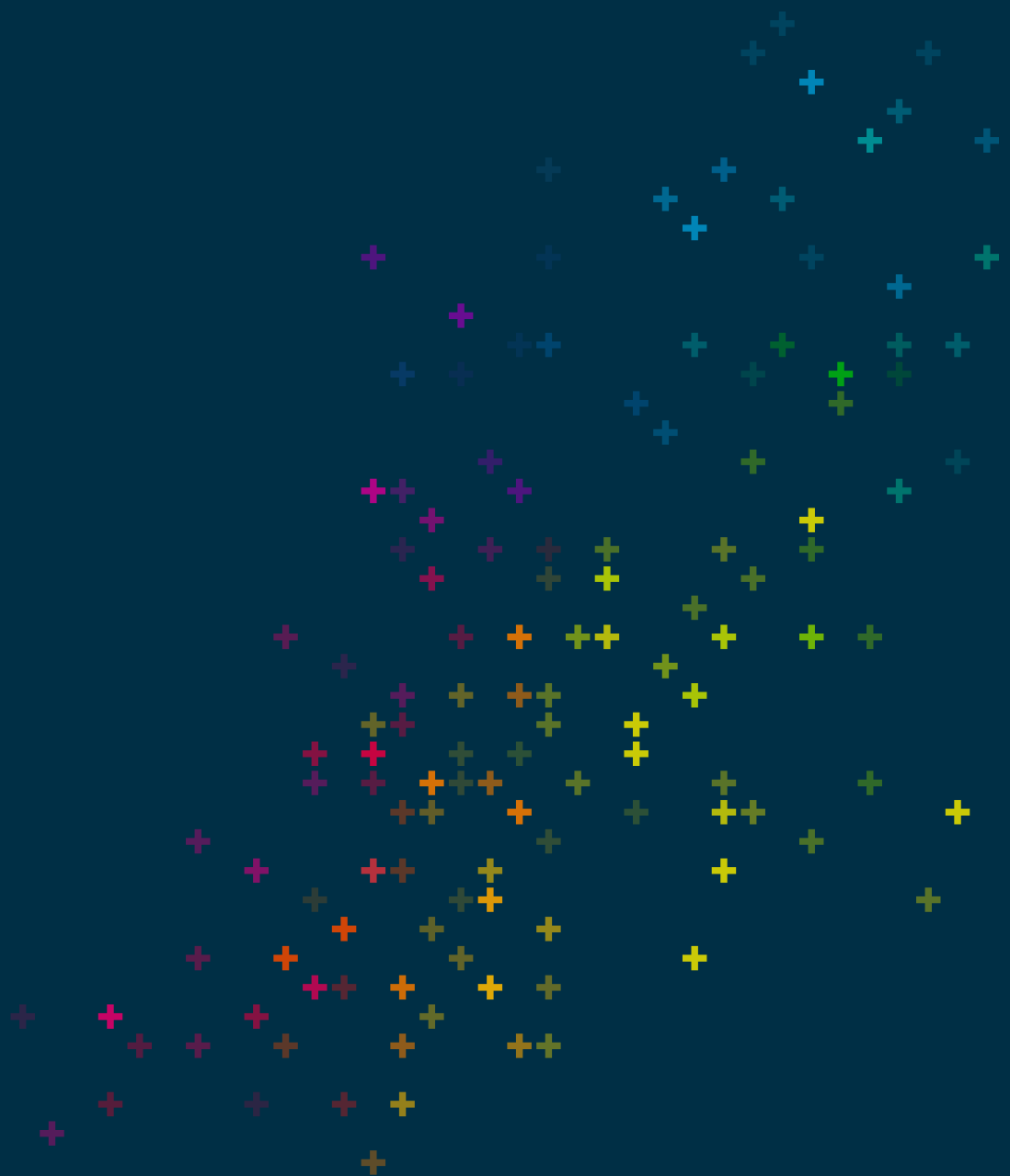

Temperature, Pressure and Service Life Tables

According to EN 15874 - 75 Standard:

Application Class (Class) 1: Hot Water Distribution 60°C	
Operating Temperature	49 years at 60°C
Maximum Operating Temperature	1 year at 80°C
Degradation Temperature	100 hours at 95°C
Maximum Operating Pressure	10 bars
Application Class (Class) 2: Hot Water Distribution 70°C	
Operating Temperature	49 years at 70°C
Maximum Operating Temperature	1 year at 80°C
Degradation Temperature	100 hours at 95°C
Maximum Operating Pressure	10 bars
Application Class (Class) 4: Underfloor Heating and Radiators at Low Temperatures	
Operating Temperature	20°C for 2,5 years
	40°C for the subsequent 20 years
	60°C for the subsequent 20 years
Maximum Operating Temperature	2,5 years at 70°C
Degradation Temperature	100 hours at 100°C
Maximum Operating Pressure	10 bars
Application Class (Class) 5: Radiators at High Temperatures	
Operating Temperature	20°C for 14 years,
	60°C for the subsequent 25 years
	80°C for the subsequent 10 years
Maximum Operating Temperature	1 year at 90°C
Degradation Temperature	100 hours at 100°C
Maximum Operating Pressure	10 bars

Standard PP-R Pipes:

SDR 11/S5.0 (PN10)	class 1/6 bar	class 2/4 bar	
SDR 7.4/S3.2 (PN16)	class 1/8 bar	class 2/6 bar	class 4/10 bar
class 5/6 bar			
SDR 6/S2.5 (PN20)	class 1/10 bar	class 2/8 bar	class 4/10 bar
class 5/6 bar			

Glass Fiber Reinforced PP-R Pipes:

SDR 11/S5.0 (PN10)	class 1/6 bar	class 2/4 bar	
SDR 7.4/S3.2 (PN20)	class 1/8 bar	class 2/6 bar	class 4/10 bar
class 5/6 bar			
SDR 6/S2.5 (PN25)	class 1/10 bar	class 2/8 bar	class 4/10 bar
class 5/6 bar			

Aluplus Stable Pipes:

SDR6/S2.5 (PN20)	class 1/6 bar
------------------	---------------

Stable Pipes:

SDR6/S2.5 (PN25)	class 1/10 bar	class 2/8 bar	class 4/10 bar
class 5/6 bar			

PE-RT, PE-XB Pipes:

Class 1-2-4/10 bar	class 5/8bar
--------------------	--------------

Glass Reinforced PP-RCT Pipes:

SDR7,4	class 1/10 bar	class 2/10 bar	class 4/10 bar
class 5/8 bar			
SDR9	class 1/8 bar	class 2/8 bar	class 4/8 bar
class 5/6 bar			

According to DIN 8077 Standard:

Maximum Operating Pressures according to DIN 8077 with safety factor of 1,5						
Operating Temperature(°C)	Service Life (year)	PP-R			PP-RCT	
		SDR 11 (S5)	SDR 7.4 (S3.2)	SDR 6 (S2.5)	SDR9 (S4)	SDR7.4 (S3.2)
10 °C*	1	17,6	27,8	35	24	30,2
	5	16,7	26,3	33,2	23,2	29,3
	10	16,1	25,6	32,1	22,9	28,9
	25	15,6	24,8	31,1	22,5	28,4
	50	15,2	24,1	30,3	22,2	28
20 °C*	1	15	23,8	30	20,9	26,3
	5	14,1	22,3	28,2	20,2	25,4
	10	13,7	21,8	27,3	19,9	25,1
	25	13,3	21	26,5	19,6	24,6
	50	12,9	20,4	25,8	19,3	24,3
30 °C	1	12,8	20,2	25,5	18,1	22,7
	5	12	18,9	23,9	17,4	22
	10	11,6	18,4	23,1	17,2	21,7
	25	11,2	17,8	22,3	16,9	21,2
	50	10,9	17,3	21,8	16,6	20,9
40 °C	1	10,8	17,2	21,5	15,5	19,6
	5	10,1	16	20,2	15	18,9
	10	9,8	15,6	19,7	14,7	18,6
	25	9,4	15	18,8	14,4	18,2
	50	9,2	14,5	18,3	14,2	17,9
50 °C	1	9,2	14,5	18,3	13,3	16,7
	5	8,5	13,5	17	12,8	16,1
	10	8,3	13,1	16,4	12,6	15,8
	25	8	12,6	15,9	12,3	15,5
	50	7,8	12,3	15,4	12,1	15,2
60 °C	1	7,8	12,3	15,4	11,2	14,2
	5	7,2	11,3	14,3	10,8	13,6
	10	6,9	11	13,8	10,6	13,4
	25	6,7	10,6	13,3	10,4	13,1
	50	6,4	10,3	12,8	10,2	12,8
70 °C	1	6,5	10,3	13	9,4	11,9
	5	6	9,5	11,9	9,1	11,4
	10	5,8	9,3	11,7	8,9	11,2
	25	5,1	8	10,1	8,7	10,9
	50	4,3	6,8	8,5	8,5	10,7
80 °C	1	5,4	8,6	10,9	7,9	9,9
	5	4,8	7,6	9,6	7,5	9,5
	10	4	6,4	8	7,4	9,3
	25	3,2	5,2	6,3	7,2	9,1
	50	2,2	3,4	4,3	5,5	6,9
95 °C	1	3,8	6,1	7,7	5,9	7,4
	5	2,5	4,1	5,1	5,6	7,1
	10	2,2	3,4	4,3	5,5	6,9

* Cold water applications.

Building Technology (BT) Product Range Installation Instructions

- GF Aquasystem PP-R and PP-RCT Piping Systems

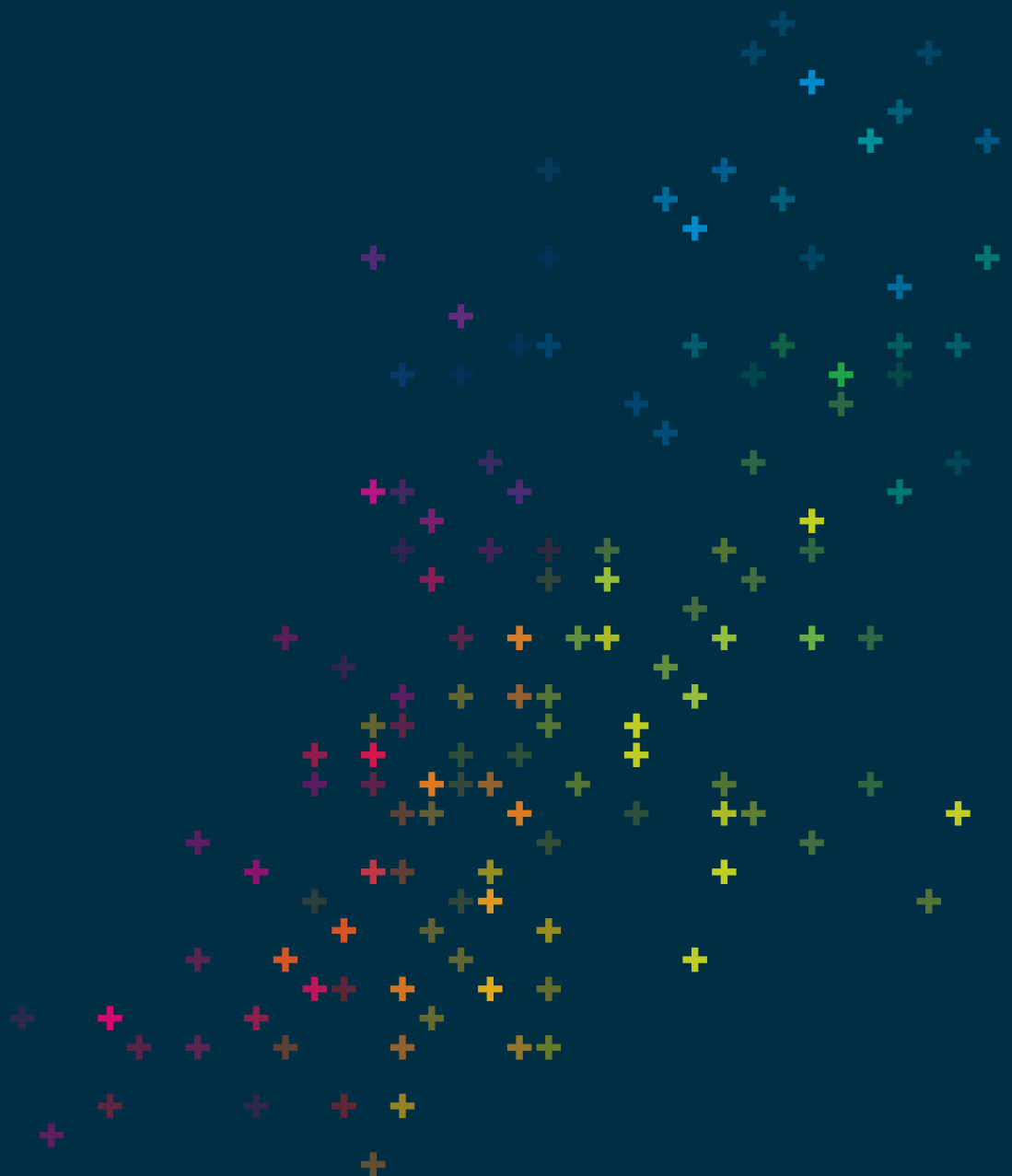

Installation

Aquasystem PP-R and PP-RCT Piping Systems

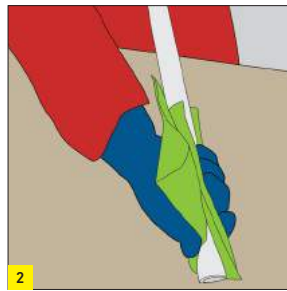
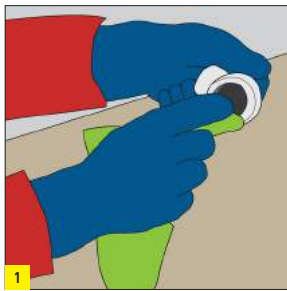

Make sure that pipes, fittings and welding machine are clean.

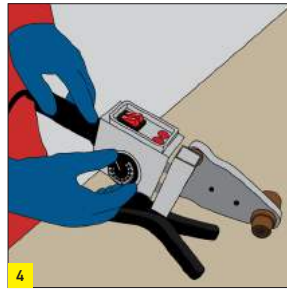
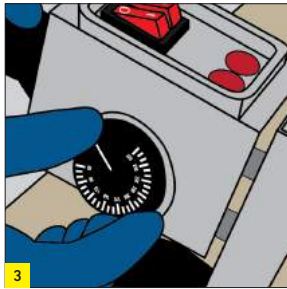

Before operating the socket fusion machine, make sure that the working area is safe. To avoid the rotation and movement of parts, welding plates should be appropriately placed into the welding machine.

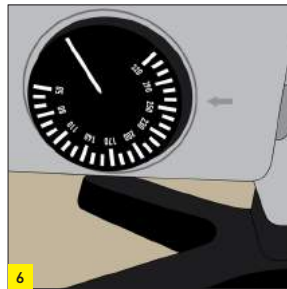
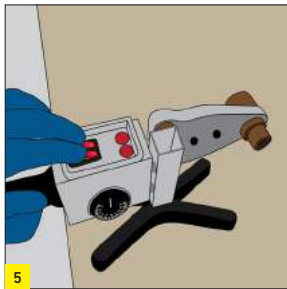

Connect the welding machine to 220 Volts standard socket. Adjust the temperature as 260°C (500 °F). Push the power button. Heating will take 1 to 3 minutes. When the temperature reaches 260°C (500°F), thermostat light will switch off automatically.

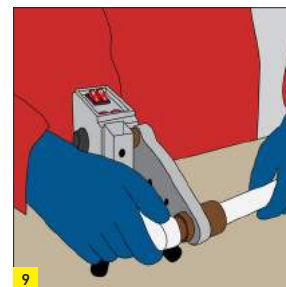
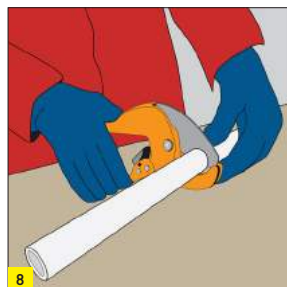
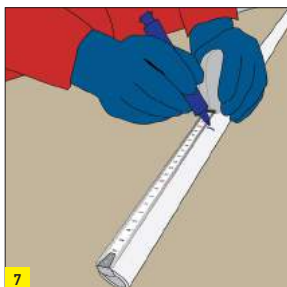

Place the pipes cut in the desired measurements and fittings into the welding plates. If foiled (stabile) pipes are used, first of all, shave the outer layer completely by using a stripper. Make trials to ensure that the blade is accurately adjusted.

Diameter [mm]	Welding Depth [mm]	Heating Time [mm]	Welding Time [s]	Cooling Time [m]
20	14	5	4	2
25	15	7	4	2
32	16,5	8	5	3
40	18	12	6	4
50	20	18	7	4
63	24	24	8	6
75	28	30	8	6
90	29	40	8	8
110	32,5	50	10	8
125	40	70	10	8
160	45	90	12	10

Pipes and fittings should be heated at the same time. Heating times vary depending upon the diameters of pipes. If you do not follow the times indicated in the table, this will cause reduction in the welding quality. If you heat them for too much time, it will cause the pipe to tighten so much and the fitting to expand extremely, resulting in loose connection.

PP-RCT Pipes are fully compatible and weldable with our PP-R fittings:

- Same tooling/equipments
- Same welding parameters
- Same assembling instructions

Installation

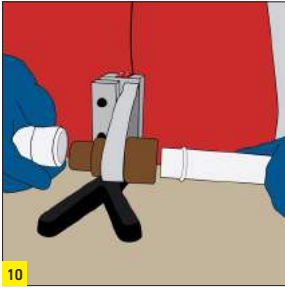

After heating, take out the pipes and fittings from the welding mould carefully.

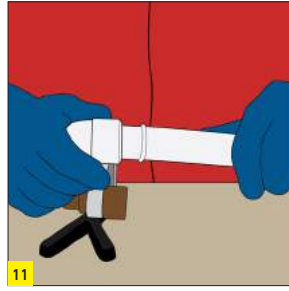

Push the pipe into the fitting at straight angle without rotating it, and joint it quickly.

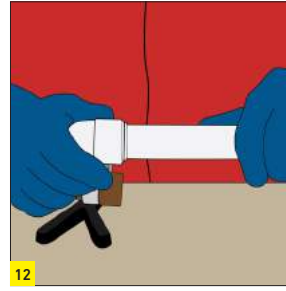

After jointing it, wait for the cooling process by following the cooling times indicated.

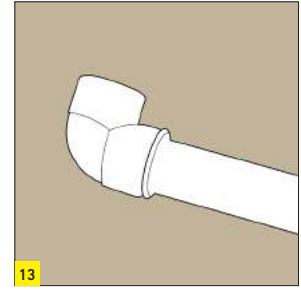

After cooling, the connection will be ready for use.

- After using it, switch off and disconnect the machine. Wait for it to cool. Never use water to cool the welder because it will damage the metal heated. Always keep the welding plates dry.
- Do not perform welding operation in ambient temperatures below 5°C. As PP-R material is fragile in cold weather conditions, treat the pipes with more attention in those conditions.
- While working with the welding machine, wear appropriate hand and arm protective gloves to avoid the risk of burning. Wearing protection goggles are also recommended. During the

operation, always beware of the position of the machine. Make sure that welding plates are tightly fitted and not loose. Always take occupational safety measures.

- Cut the pipes vertically by using the proper cutters. Make sure that the cutters are sharp.
- To guarantee a perfect connection, make sure that the surfaces of the welding plates are in good quality and the surfaces are always clean.

Test Instructions

Upon completion of the pipe installation, the installation should be absolutely tested according to the following testing method. After making the controls, the installation should be switched off.

Testing Method i

- 1- All valves in the installation are switched off.
- 2- During the supply of water into the installation, the main valve is switched on, but it should not be switched on too much. To protect the installation against strong pressure impacts, the air of the installation is carefully released at the highest and the farthest point of the line.
- 3- Fill the installation with water slowly until water comes out at such point.
- 4- The valves of each area of the installation to be tested are switched on and separately tested.

Starting the Test

Pressure test is carried out in two steps.

Step 1: Testing is conducted for 30 minutes by 1.5 times more of the highest operating pressure prescribed in the entire piping installation within the building. During this period of time, the installation is observed in terms of pressure drop and leakage in the minute 10 and 20. If there is pressure drop but not leakage, then water is re-supplied and restored to the testing pressure.

Step 2: Pressure is applied for 2 hours by 1.5 fold of the highest operating pressure prescribed in the entire piping installation within the building. There should not be any pressure drop at the end of such 2 hours.

The lines not to be used in the testing should be switched off and each area should be separately tested. If, at the end of the testing, the installation will not be used, it should be absolutely discharged. In terms of freezing, no water should be available in the line not to be used.

Thermal Expansions

Linear expansion of pipes depends upon the difference between the operating temperature and installation temperature:

$$\Delta T = T_{\text{Operating Temperature}} - T_{\text{Installation Temperature}}$$

Therefore, thermal expansion values of cold water applications could be neglected. For hot water applications, the expansions should be calculated due to the linear expansion depending upon the temperature of the material, and the clamp distances should be adjusted based on the tables.

It should be taken into account that the critical parameter is thermal expansion coefficient.

- Linear expansion coefficient of Aquasystem PP-R Standard pipes is **0.150 mm/m°K**.
- Linear expansion coefficient of Aquasystem Faser Fiberglass Reinforced and Climafaser Fiberglass Reinforced PP-R pipes is **0.035 mm/m°K**.
- Linear expansion coefficient of Aquasystem Aluminum Foiled (Stable-Aluplus) PP-R pipes is **0.030 mm/m°K**.

Installation

Total linear expansion of PP-R system is calculated according to the following formula:

$$\Delta L = L_o \times \alpha \times \Delta T$$

ΔL ; Linear Expansion (mm)

L_o ; Pipe Installation Length (m)

α ; Linear coefficient of thermal expansion

ΔT ; Temperature Difference Between Operating and

Installation Temperature

(°K, °C or °F)

For example, 2 m-long Aquasystem Glass Fiber Reinforced (Faser) PP-R pipe operates at 65°C and installed at 25°C, rectilinear expansion is calculated as follows:

$$\Delta L = L_o \times \alpha \times \Delta T$$

$$\Delta L = 2 \times 0,035 \times 40$$

$$\Delta L = 2,8 \text{ mm}$$

Briefly, if a 2 meter long system is made with Aquasystem Glass Fiber Reinforced PP-R product and is exposed to 40°C temperature difference, the system demonstrates 2,8 mm thermal expansion.

The following tables indicate the example expansion calculations with different temperature differences of products with different thermal expansion coefficients.

Pipe Length (m)	Thermal Expansion of Standard PP-R Pipes [mm] $\alpha = 0.150 \text{ mm/m}^\circ\text{K}$							
	Temperature Differences (°C)							
	10°C	20°C	30°C	40°C	50°C	60°C	70°C	80°C
1,0	1,5	3,0	4,5	6,0	7,5	9,0	10,5	12,0
2,0	3,0	6,0	9,0	12,0	15,0	18,0	21,0	24,0
3,0	4,5	9,0	13,5	18,0	22,5	27,0	31,5	36,0
4,0	6,0	12,0	18,0	24,0	30,0	36,0	42,0	48,0
5,0	7,5	15,0	22,5	30,0	37,5	45,0	52,5	60,0
6,0	9,0	18,0	27,0	36,0	45,0	54,0	63,0	72,0
7,0	10,5	21,0	31,5	42,0	52,5	63,0	73,5	84,0
8,0	12,0	24,0	36,0	48,0	60,0	72,0	84,0	96,0
9,0	13,5	27,0	40,5	54,0	67,5	81,0	94,5	108,0
10,0	15,0	30,0	45,0	60,0	75,0	90,0	105,0	120,0

Pipe Length (m)	Thermal Expansion of Glass Fiber Reinforced (Faser) PP-R Pipes [mm] $\alpha = 0.035 \text{ mm/m}^\circ\text{K}$							
	Temperature Differences (°C)							
	10°C	20°C	30°C	40°C	50°C	60°C	70°C	80°C
1,0	0,4	0,7	1,1	1,4	1,8	2,1	2,5	2,8
2,0	0,7	1,4	2,1	2,8	3,5	4,2	4,9	5,6
3,0	1,1	2,1	3,2	4,2	5,3	6,3	7,4	8,4
4,0	1,4	2,8	4,2	5,6	7,0	8,4	9,8	11,2
5,0	1,8	3,5	5,3	7,0	8,8	10,5	12,3	14,0
6,0	2,1	4,2	6,3	8,4	10,5	12,6	14,7	16,8
7,0	2,5	4,9	7,4	9,8	12,3	14,7	17,2	19,6
8,0	2,8	5,6	8,4	11,2	14,0	16,8	19,6	22,4
9,0	3,2	6,3	9,5	12,6	15,8	18,9	22,1	25,2
10,0	3,5	7,0	10,5	14,0	17,5	21,0	24,5	28,0

Pipe Length (m)	Thermal Expansion of Aluminum Foil PP-R Pipes [mm] $\alpha = 0.030 \text{ mm/m}^\circ\text{K}$							
	Temperature Differences (°C)							
	10°C	20°C	30°C	40°C	50°C	60°C	70°C	80°C
1,0	0,3	0,6	0,9	1,2	1,5	1,8	2,1	2,4
2,0	0,6	1,2	1,8	2,4	3,0	3,6	4,2	4,8
3,0	0,9	1,8	2,7	3,6	4,5	5,4	6,3	7,2
4,0	1,2	2,4	3,6	4,8	6,0	7,2	8,4	9,6
5,0	1,5	3,0	4,5	6,0	7,5	9,0	10,5	12,0
6,0	1,8	3,6	5,4	7,2	9,0	10,8	12,6	14,4
7,0	2,1	4,2	6,3	8,4	10,5	12,6	14,7	16,8
8,0	2,4	4,8	7,2	9,6	12,0	14,4	16,8	19,2
9,0	2,7	5,4	8,1	10,8	13,5	16,2	18,9	21,6
10,0	3,0	6,0	9,0	12,0	15,0	18,0	21,0	24,0

Installation

Thermal Elongation Compensation

All piping systems need adequate gap for thermal expansion. The necessary gaps should be created on the system through thermal expansion compensation so that no extra tension is created on the system due to temperature differences and the system is not damaged. In the vertical lines (riser), thermal expansion compensation is not required. However, in the horizontal lines, thermal expansion compensations should be included into the system by using the following calculations and designs.

Free Expansion

Fixed Points (FP) blocks the undesired movements of the system. These fixed points are created by using fasteners. Fixed points should be more resistant and stable than sliding points (SP). It is not recommended to use fixed points at bending areas.

Thermal expansion compensation can be calculated according to the following formula by taking the free movements into consideration:

$$A_{min} = 2 \times \Delta L + SD$$

- A_{min} : Minimum thermal expansion compensation width (mm)
- SD: Safety gap (150 mm)
- ΔL : Total elongation of the system from fixed point (mm)

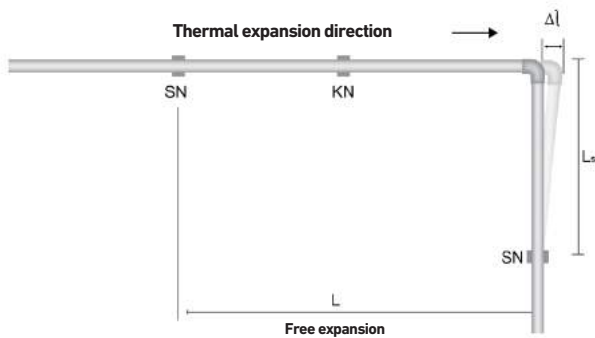

The adjustments of thermal expansion compensation are generally calculated as uniaxial (along the pipe). To avoid any additional stress in the system, PP-R pipes should freely expand in the axial direction.

Safety gap specified as 150 mm should be increased if there are temperature difference fluctuations in the system.

If the system is biaxial (horizontal and vertical) and longer than 5 m, thermal expansions should be calculated and the following expansion cycles should be used.

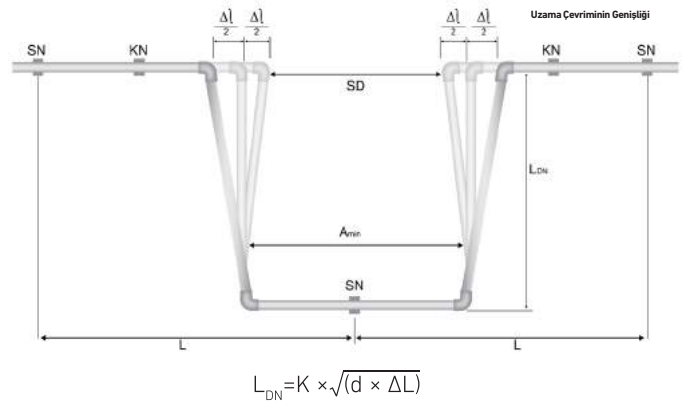

- SF; Fixed Point
- SP; Sliding Point
- L_{DN} ; Length of free bending part (mm)
- d; External diameter of pipe (mm)
- L; Length of pipe
- ΔL ; Total thermal expansion (or contraction) (mm)
- L; Pipe Length (m)
- K; Material constant (K=30)

Distances Between Clamps in PP-R Installation:

Standard PP-R Pipes	Temperature Difference	Clamp Distances (cm)										
	ΔT (°C)	d20	d25	d32	d40	d50	d63	d75	d90	d110	d125	d160
	0	85	105	125	140	165	190	205	220	250	270	290
	20	60	75	90	100	120	140	150	160	180	200	230
	30	60	75	90	100	120	140	150	160	180	200	230
	40	60	70	80	90	110	130	140	150	170	180	200
	50	60	70	80	90	110	130	140	150	170	180	200
	60	55	65	75	85	100	115	125	140	160	170	180
	70	50	60	75	80	95	105	115	125	140	155	180

Installation

Glass Reinforced PP-R	Temperature Difference	Clamp Distances (cm)										
	ΔT (°C)	d20	d25	d32	d40	d50	d63	d75	d90	d110	d125	d160
	0	115	130	150	165	185	215	240	260	280	300	320
	20	90	100	115	130	145	165	185	200	215	225	250
	30	90	100	115	130	145	165	185	200	210	235	255
	40	80	90	105	120	135	155	175	190	200	215	230
	50	80	90	105	120	135	155	175	190	180	200	210
	60	70	80	100	115	130	145	165	180	175	190	200
	70	65	75	90	105	120	135	155	175	175	190	200

Aluminum Foil Pipes	Temperature Difference	Clamp Distances (cm)										
	ΔT (°C)	d20	d25	d32	d40	d50	d63	d75	d90	d110	d125	d160
	0	120	140	160	180	205	230	245	260	280	300	320
	20	90	105	120	135	155	175	185	200	215	225	250
	30	90	105	120	135	155	175	185	200	210	235	255
	40	85	95	110	125	145	165	175	190	200	215	230
	50	85	95	110	125	145	165	175	190	180	200	210
	60	80	90	105	120	135	155	165	180	175	190	200
	70	70	80	95	110	130	145	165	175	175	190	200

Packaging, Storage and Transportation

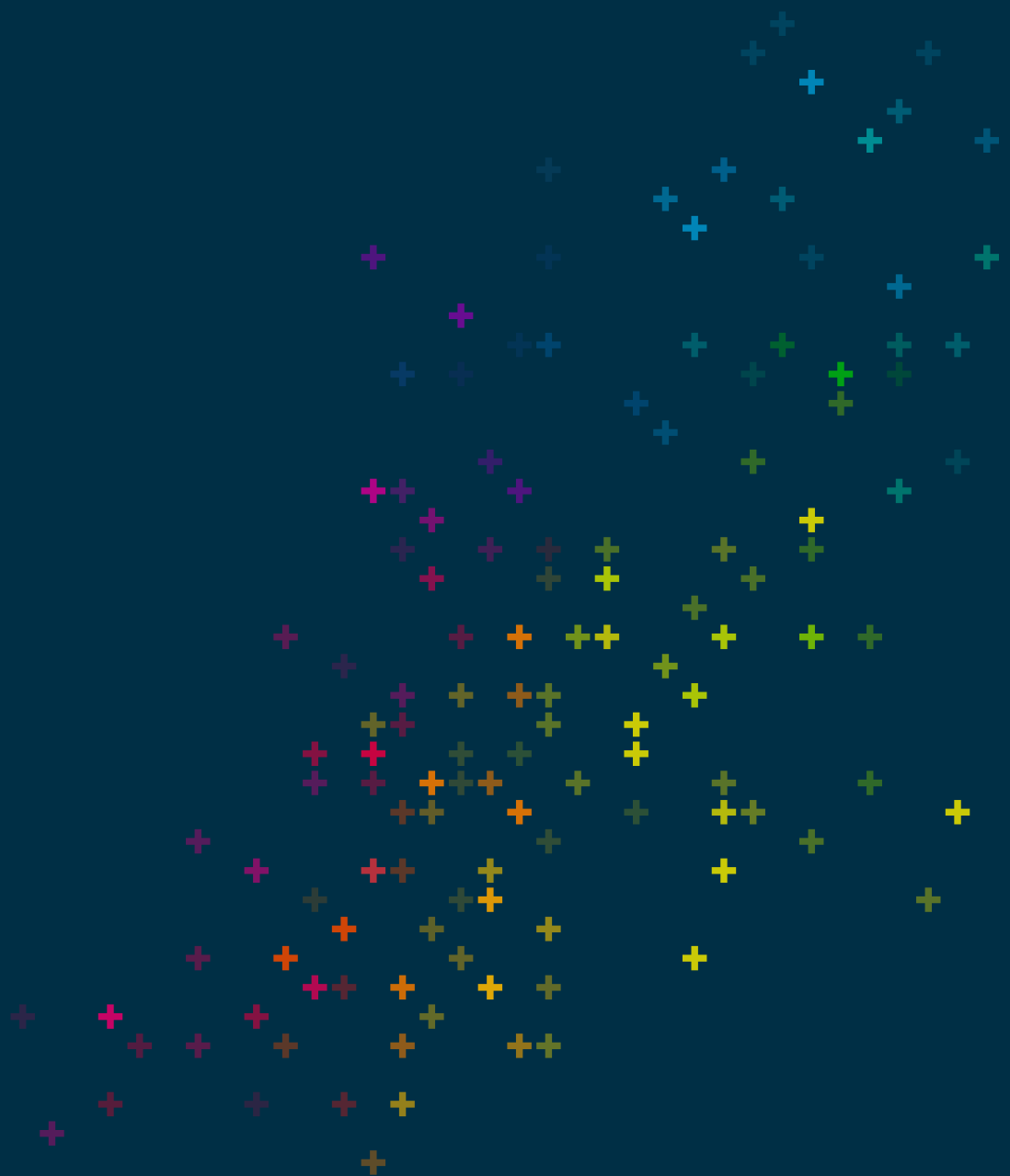

Packaging

GF Hakan Plastik pipes and fittings are packed as ready for transport in a customer-friendly way. Packing ensures safety, efficient storage and easy transport.

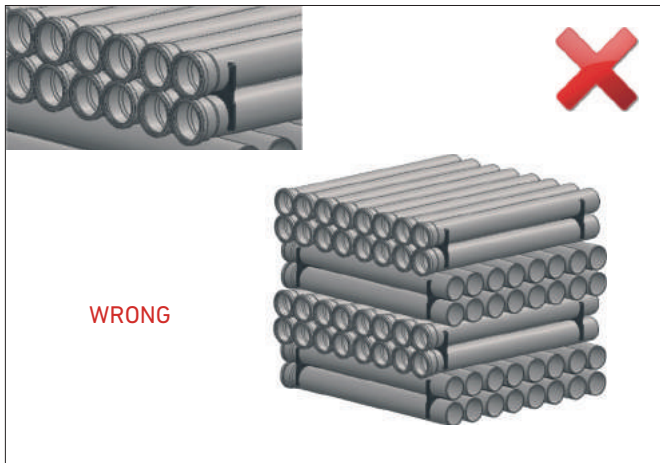
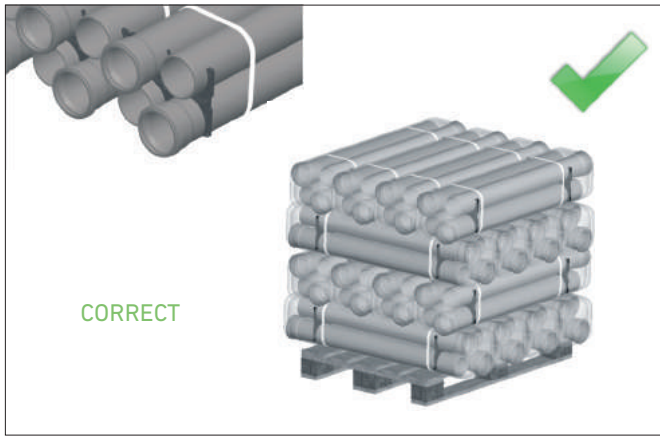

Pipes and fittings with socket are placed in a way that they will not stay on top of each other.



Pipes are packed by plastic clamps to hold them together. Stretch film is applied to protect pipes from pipes dust and stains.



Waste water pipes are shipped on wooden frames or pallets according to the demands of customers.

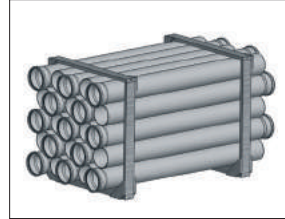

Short parts with the length of 150, 250 and 500 mm are packed in carton boxes like connection parts.



All product ranges are identified in the Warehouse Management System (WMS) by barcode label. Barcode system ensures management of products and prevents complexity and errors during storage and loading.

Storage

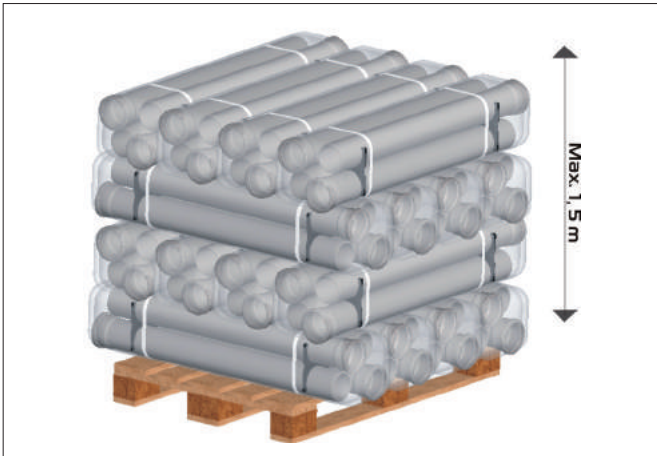

Method of storage should not cause any outflow and should not damage the pipes. As long as they are stored properly, no permanent deformations or damages will occur on the pipes and fittings. Pipes should not be stacked above 1,5 m. Pipes should be safe against sliding.

Pipes packed in the factory might be stacked on wooden frames. Appropriate materials such as pallet etc. should be used to prevent any damage on the socket parts of the pipes stored for a long time. This also makes it easier to lift the pipes by from the floor.

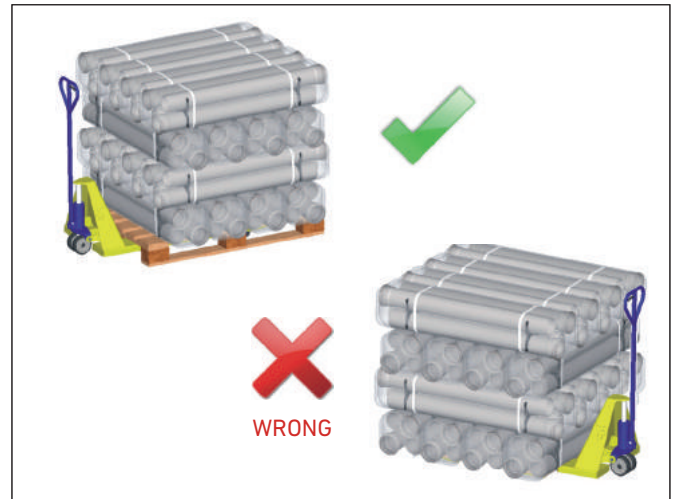

Pipes and fittings packed in carton boxes should be protected against moisture. Carton boxes should be sealed and stored in a dry area.

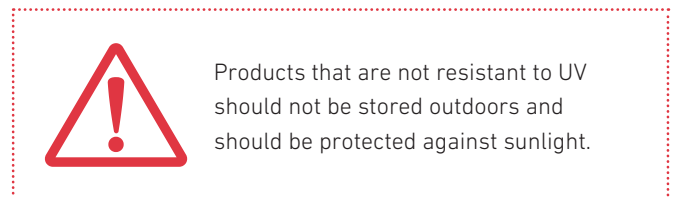

Transportation

Pipes should be carefully transported to prevent any damages. Avoid sudden and hard pressures on pipes and fittings that might cause freezing in cold weather conditions. Ensure that pipes are not slid and dropped on the floor. Loading and unloading and packing of pipes in a block should be carried out by means of forklifts having flat threads and extensions.

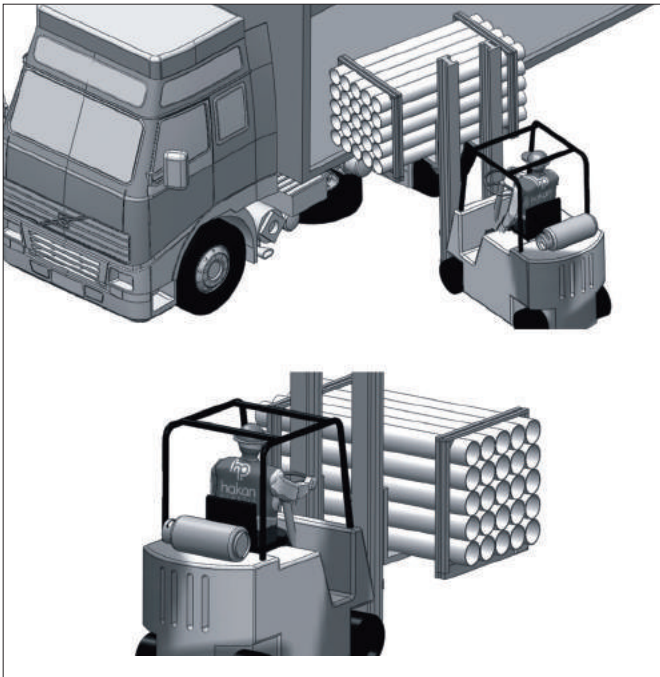

Worldwide at home

Our sales companies and representatives ensure local customer support in more than 100 countries.

www.gfps.com

Argentina / Southern South America

Georg Fischer Central Plastics Sudamérica S.R.L.
Buenos Aires / Argentina
Phone +54 11 4512 02 90
gfccentral.ps.ar@georgfischer.com
www.gfps.com/ar

Australia

George Fischer Pty Ltd
Riverwood NSW 2210
Phone +61 (0) 2 9502 8000
australia.ps@georgfischer.com
www.gfps.com/au

Austria

Georg Fischer Rohrleitungssysteme GmbH
3130 Herzogenburg
Phone +43 (0) 2782 856 43-0
austria.ps@georgfischer.com
www.gfps.com/at

Belgium / Luxembourg

Georg Fischer NV/SA
1600 Sint-Pieters-Leeuw / Belgium
Phone +32 (0) 2 556 40 20
Fax +32 (0) 2 524 34 26
be.ps@georgfischer.com
www.gfps.com/be

Brazil

Georg Fischer Sist. de Tub. Ltda.
04571-020 São Paulo/SP
Phone +55 (0) 11 5525 1311
br.ps@georgfischer.com
www.gfps.com/br

Canada

Georg Fischer Piping Systems Ltd
Mississauga, ON L5T 2B2
Phone +1 (905) 670 8005
Fax +1 (905) 670 8513
ca.ps@georgfischer.com
www.gfps.com/ca

China

Georg Fischer Piping Systems Ltd
Shanghai 201319
Phone +86 21 3899 3899
china.ps@georgfischer.com
www.gfps.com/cn

Denmark / Iceland

Georg Fischer A/S
2630 Taastrup / Denmark
Phone +45 (0) 70 22 19 75
info.dk.ps@georgfischer.com
www.gfps.com/dk

Finland

Georg Fischer AB
01510 Vantaa
Phone +358 (0) 9 586 58 25
Fax +358 (0) 9 586 58 29
info.fi.ps@georgfischer.com
www.gfps.com/fin

France

Georg Fischer SAS
95932 Roissy Charles de Gaulle Cedex
Phone +33 (0) 1 41 84 68 84
fr.ps@georgfischer.com
www.gfps.com/fr

Germany

Georg Fischer GmbH
73095 Albershausen
Phone +49 (0) 7161 302 0
info.de.ps@georgfischer.com
www.gfps.com/de

India

Georg Fischer Piping Systems Pvt. Ltd
400 083 Mumbai
Phone +91 22 4007 2000
Fax +91 22 4007 2020
branchoffice@georgfischer.com
www.gfps.com/in

Indonesia

PT Georg Fischer Indonesia
Karawang 41371, Jawa Barat
Phone +62 267 432 044
Fax +62 267 431 857
indonesia.ps@georgfischer.com
www.gfps.com/id

Italy

Georg Fischer S.p.A.
20864 Agrate Brianza (MB)
Phone +39 02 921 86 1
Fax +39 02 921 86 24 7
it.ps@georgfischer.com
www.gfps.com/it

Japan

Georg Fischer Ltd
530-0003 Osaka
Phone +81 (0) 6 6341 2451
jp.ps@georgfischer.com
www.gfps.com/jp

Korea

Georg Fischer Korea Co. Ltd
Unit 2501, U-Tower
120 Heungdeok Jungang-ro
(Yeongdeok-dong)
Giheung-gu, Yongin-si, Gyeonggi-do
Phone +82 31 8017 1450
Fax +82 31 217 1454
kor.ps@georgfischer.com
www.gfps.com/kr

Malaysia

Georg Fischer (M) Sdn. Bhd.
41200 Klang, Selangor Darul Ehsan
Phone +60 (0) 3 3122 5585
Fax +60 (0) 3 3122 5575
my.ps@georgfischer.com
www.gfps.com/my

Mexico / Northern Latin America

Georg Fischer S.A. de C.V.
CP 66603 Apodaca, Nuevo León / Mexico
Phone +52 (81) 1340 8586
Fax +52 (81) 1522 8906
mx.ps@georgfischer.com
www.gfps.com/mx

Middle East

Georg Fischer Piping Systems (Switzerland) Ltd
Dubai / United Arab Emirates
Phone +971 4 289 49 60
gcc.ps@georgfischer.com
www.gfps.com/int

Netherlands

Georg Fischer N.V.
8161 PA Epe
Phone +31 (0) 578 678 222
nl.ps@georgfischer.com
www.gfps.com/nl

New Zealand

Georg Fischer Ltd
5018 Upper Hutt
Phone +04 527 9813
Fax +04 527 9834
nz.ps@georgfischer.com
www.gfps.com/nz

Norway

Georg Fischer AS
1351 Rud
Phone +47 67 18 29 00
no.ps@georgfischer.com
www.gfps.com/no

Philippines

George Fischer Pte. Ltd.
Philippines Representative Office
1500 San Juan City
Phone +632 571 2365
Fax +632 571 2368
sgp.ps@georgfischer.com
www.gfps.com/sg

Poland

Georg Fischer Sp. z o.o.
05-090 Sekocin Nowy
Phone +48 (0) 22 31 31 0 50
poland.ps@georgfischer.com
www.gfps.com/pl

Romania

Georg Fischer Piping Systems (Switzerland) Ltd
020257 Bucharest - Sector 2
Phone +40 (0) 21 230 53 80
ro.ps@georgfischer.com
www.gfps.com/int

Russia

Georg Fischer Piping Systems (Switzerland) Ltd
Moscow 125040
Phone +7 495 748 11 44
ru.ps@georgfischer.com
www.gfps.com/ru

Singapore

Georg Fischer Pte Ltd
528 872 Singapore
Phone +65 6747 0611
Fax +65 6747 0577
sgp.ps@georgfischer.com
www.gfps.com/sg

Spain / Portugal

Georg Fischer S.A.
28046 Madrid / Spain
Phone +34 (0) 91 781 98 90
es.ps@georgfischer.com
www.gfps.com/es

Sweden

Georg Fischer AB
117 43 Stockholm
Phone +46 (0) 8 506 775 00
info.se.ps@georgfischer.com
www.gfps.com/se

Switzerland

Georg Fischer Rohrleitungssysteme (Schweiz) AG
8201 Schaffhausen
Phone +41 (0) 52 631 3026
ch.ps@georgfischer.com
www.gfps.com/ch

Taiwan

Georg Fischer Co. Ltd
San Chung Dist., New Taipei City
Phone +886 2 8512 2822
Fax +886 2 8512 2823
www.gfps.com/tw

United Kingdom / Ireland

Georg Fischer Sales Limited
Coventry, CV2 2ST / United Kingdom
Phone +44 (0) 2476 535 535
uk.ps@georgfischer.com
www.gfps.com/uk

USA / Caribbean

Georg Fischer LLC
92618 Irvine, CA / USA
Phone +1 714 731 8800
Fax +1 714 731 6201
us.ps@georgfischer.com
www.gfps.com/us

Vietnam

Georg Fischer Pte Ltd
Representative Office
Ho Chi Minh City
Phone +84 28 3948 4000
Fax +84 28 3948 4010
sgp.ps@georgfischer.com
www.gfps.com/vn

International

Georg Fischer Piping Systems (Switzerland) Ltd
8201 Schaffhausen / Switzerland
Phone +41 (0) 52 631 3003
Fax +41 (0) 52 631 2893
info.export@georgfischer.com
www.gfps.com/int

The information and technical data (altogether "Data") herein are not binding, unless explicitly confirmed in writing. The Data neither constitutes any expressed, implied or warranted characteristics, nor guaranteed properties or a guaranteed durability. All Data is subject to modification. The General Terms and Conditions of Sale of Georg Fischer Piping Systems apply.

Georg Fischer Hakan Plastik Boru ve Profil San. Tic. A.Ş.

www.gfps.com/tr

f t i YouTube in /gfhakanplastik

Regional Directorates

İstanbul

Ofishane Plaza
Merkez Mahallesi Cendere Caddesi
No:22 Kat:11
34400 Kağıthane / İSTANBUL
Tel: +90 212 809 20 33 (pbx)
Fax: +90 212 809 20 37

Antalya

İnci Plaza Yenigün Mh. 1054. Sok.
No:15 Ofis No:8
Muratpaşa / ANTALYA
Tel: +90 242 321 58 03
Fax: +90 242 321 58 53

Diyarbakır

Şanlıurfa Bulvarı Fırat Mh.
Ahmede Hani Cd. No:4
Yektower İş Merkezi No:13/39
Kayapınar / DİYARBAKIR
Tel: +90 412 251 18 20
Fax: +90 412 251 18 25

Samsun

Kuzey Yıldızı Mah. 100.Yıl Bulv.
No:38 Kat:4 Daire:23 Baran Plaza
Canik / SAMSUN
Tel: +90 362 256 02 33 - 03 33

Ankara

Mustafa Kemal Mahallesi
2131. Cadde Akay İş Merkezi 30-9
Çankaya / ANKARA

Production Facilities

Tekirdağ / Çerkezköy

Organize San. Bölgesi Gaziosmanpaşa
Mh. 3. Cd. No:11-13
Çerkezköy / TEKİRDAĞ
Tel: +90 282 726 64 43 (pbx)
Fax: +90 282 726 99 33

Şanlıurfa

Şanlıurfa-Gaziantep Karayolu 16. Km
2. Organize San. Bölgesi 1. Cd. No:3
ŞANLIURFA
Tel: +90 414 369 18 30
Fax: +90 414 369 17 96

