

Hyclean Automation System

# Drinking water installation smart & digital

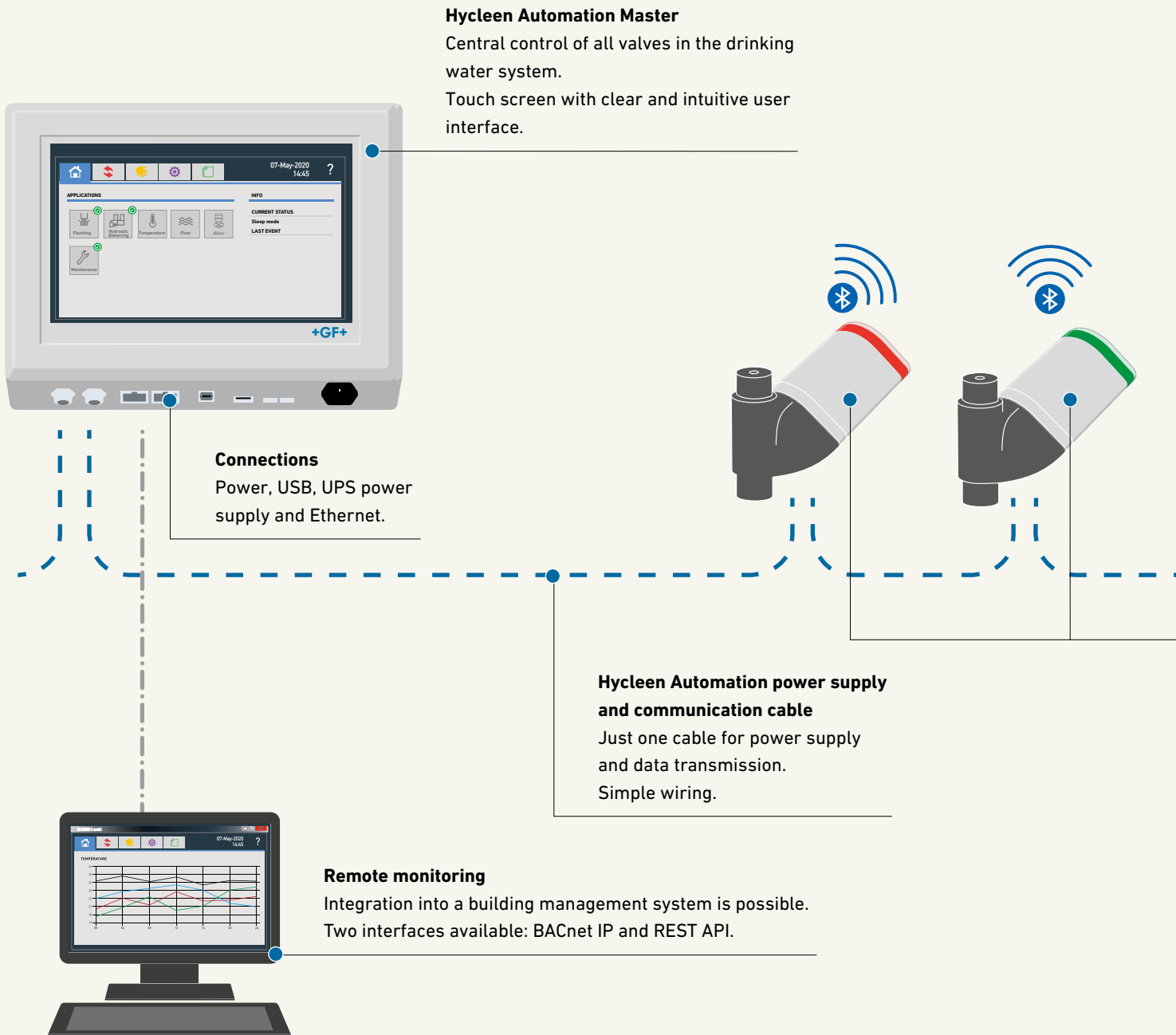

# Automatic control and monitoring of drinking water installations



The Hycleen Automation System from GF Piping Systems supports the maintenance of drinking water hygiene in large buildings. It ensures stable water temperatures, flushes the pipes, maintains the circulation valves, and logs all data. The system is easy to install and commission. And energy consumption can be optimized without increasing the risk of legionella. Valves with sensors and controllers are connected to the central control unit, the Master, via just one cable for power supply and data transmission. The Master monitors the sensors, reports any abnormalities and controls the system. This can also be operated via the app from any location and is easily integrated into the building management system.

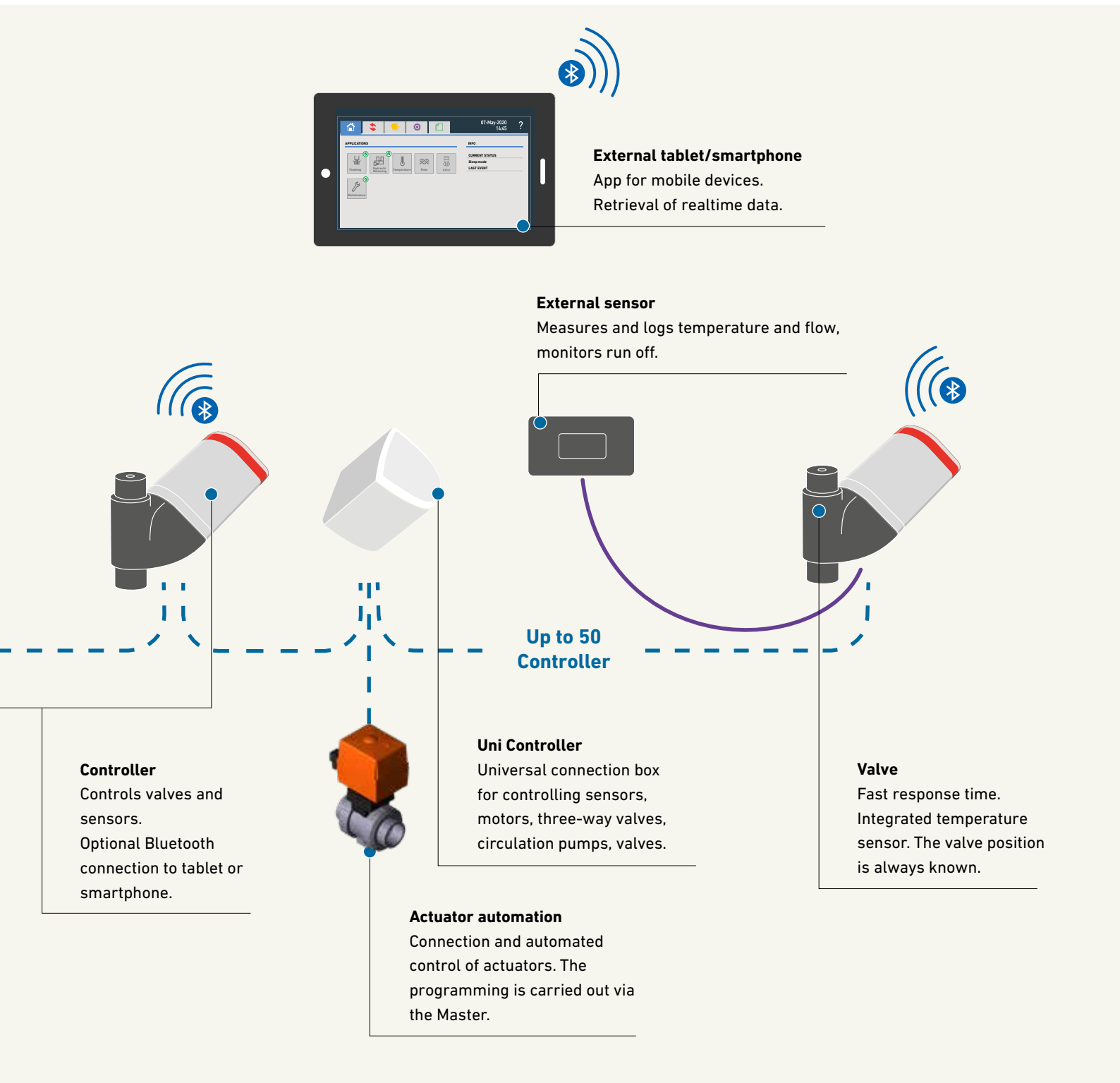

**External tablet/smartphone**  
App for mobile devices.  
Retrieval of realtime data.

**External sensor**  
Measures and logs temperature and flow,  
monitors run off.

**Up to 50  
Controller**

**Uni Controller**  
Universal connection box  
for controlling sensors,  
motors, three-way valves,  
circulation pumps, valves.

**Actuator automation**  
Connection and automated  
control of actuators. The  
programming is carried out via  
the Master.

**Controller**  
Controls valves and  
sensors.  
Optional Bluetooth  
connection to tablet or  
smartphone.

**Valve**  
Fast response time.  
Integrated temperature  
sensor. The valve position  
is always known.

## Applications

# Drinking water hygiene for complex buildings

Numerous operators of complex buildings such as hotels, hospitals, schools, apartment blocks or industrial plants use the Hycleen Automation System for optimizing drinking water hygiene. The system can be installed in both new and existing buildings.



**Riku Tuomeinen, Sales Company  
Finland**



The commissioning of the Hycleen Automation System in the new production plants of customer HögforsGST took just 15 minutes – no manual adjustments to the valves or parameters. The system is the perfect solution for improve water hygiene and optimizing energy consumption.



**Installation engineer  
Belgium**



Although we were installing the Hycleen Automation System for the first time, everything ran smoothly and required very little time. Commissioning was self-explanatory and worked perfectly. The cabling solution is impeccable. I'm looking forward to the next installation.



**Roman Greisl, Sales Company  
Germany**



Software update 2.0 ran without any problems, despite this being my first project with the Hycleen Automation System. Commissioning was simple and concluded very quickly. Drinking water hygiene in the holiday home was very important to the customer. The installation was equipped with six flushing valves and three circulation regulators. Both the end customer and the installation engineer are very impressed by the system.

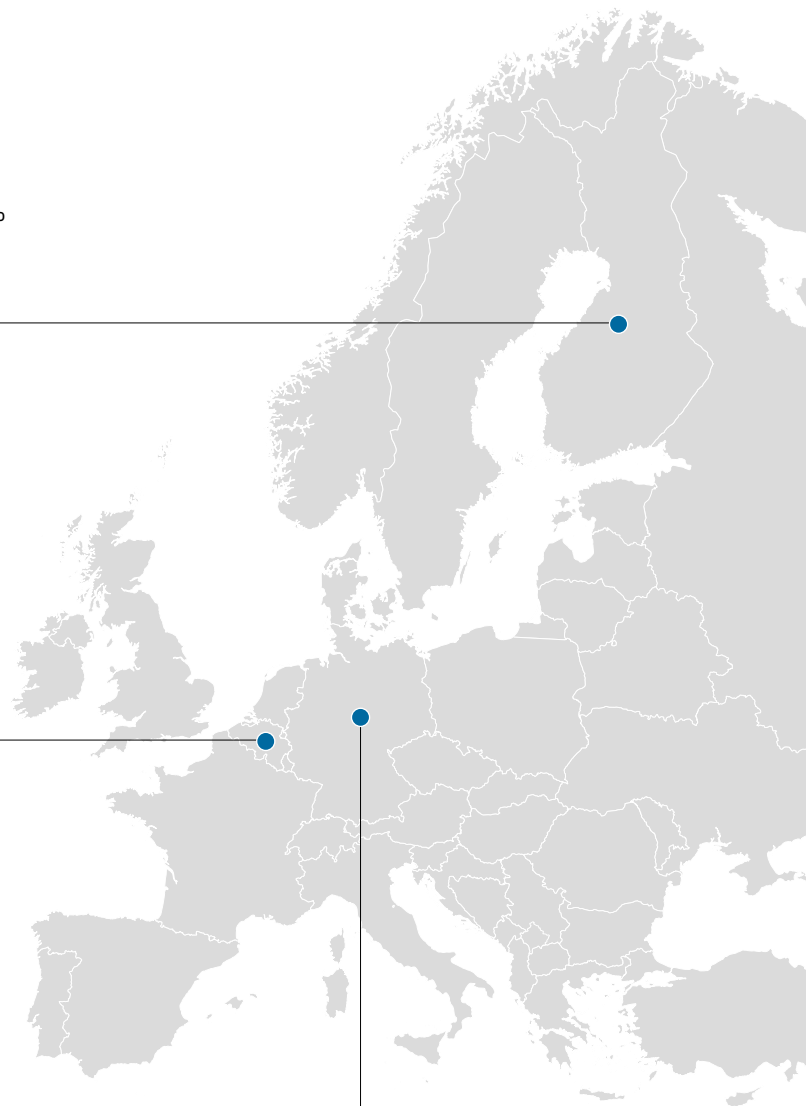

# Your benefits

	For planners/installation engineers	For technical managers	For commercial managers
 <p><b>Hygiene</b></p>	<ul style="list-style-type: none"> <li>• Support in project processing through competent assistance</li> <li>• Modular planning tool, including BIM and CAD database</li> <li>• High flexibility thanks to the latest automation technology</li> <li>• Hydraulic balancing easily guaranteed in new or existing buildings</li> <li>• Continuous development of the system based on many years of experience and research in the field of drinking water hygiene</li> </ul>	<ul style="list-style-type: none"> <li>• High degree of safety thanks to continuous monitoring of the critical system parameters (temperature, flows, etc.)</li> <li>• Automatic alarm in case of malfunctions or deviations</li> <li>• Remote monitoring and remote control via Hycleen Connect possible</li> <li>• System optimization through the detection of vulnerabilities</li> <li>• Automatic weekly maintenance of the electric valves</li> </ul>	<ul style="list-style-type: none"> <li>• Enables permanent compliance with the legal temperature limits</li> <li>• Continuous traceability thanks to automatic logging function</li> <li>• Early problem detection minimizes the risk of consequential costs</li> <li>• Prevention of intervention measures and the associated costs</li> </ul>
 <p><b>Convenience</b></p>	<ul style="list-style-type: none"> <li>• Reliable, fast planning thanks to simple rules for dimensioning</li> <li>• Simplified calculation of the hydraulic balance thanks to substantiated data basis</li> <li>• Applications and parameters easy to program</li> </ul>	<ul style="list-style-type: none"> <li>• Carefree commissioning with plug &amp; play</li> <li>• Intelligent data evaluation for continuous system adjustment</li> <li>• Short response time through alerts in case of malfunctions in the drinking water installation</li> <li>• Standards-compliant logging based on legal requirements</li> <li>• Easy digital adjustment in case of changes to limit values under the relevant standards</li> </ul>	<ul style="list-style-type: none"> <li>• System commissioned quickly and simply, no costs for manual valve adjustment</li> <li>• Regular automatic maintenance of valves, no additional costs</li> <li>• Less risk of a system breakdown thanks to permanent data analysis and preventative maintenance</li> <li>• Early detection of system breakdowns (circulation pump for example)</li> <li>• Clearly arranged dashboards for simple analysis of the system status</li> </ul>
 <p><b>Energy optimization</b></p>	<ul style="list-style-type: none"> <li>• Targeted compliance with today's and future legally prescribed energy saving measures</li> <li>• Compliance with the Green Building concept and the certification standards of BREEAM, LEED or other labels through high flexibility</li> </ul>	<ul style="list-style-type: none"> <li>• Permanent temperature monitoring and regulation</li> <li>• Facility to optimize the system by lowering the system temperature to the legally prescribed minimum</li> <li>• Reduction of the flow through optimized leakage rates and performance regulation of the circulation pump</li> <li>• Energy consumption reduced while ensuring drinking water hygiene at the same time</li> </ul>	<ul style="list-style-type: none"> <li>• Energy savings through the option of reducing the system temperature to the legally prescribed minimum</li> <li>• Energy saving potential through dynamic and continuous system monitoring</li> <li>• Investment often returned quickly thanks to the energy saved</li> </ul>
 <p><b>Simplicity</b></p>	<ul style="list-style-type: none"> <li>• Conventional interfaces for the building management system (BACnet IP and REST API)</li> <li>• Easy installation in new or existing systems</li> <li>• One Master for controlling all applications</li> <li>• Automation of the drinking water installation made simple with the actuator automation application</li> </ul>	<ul style="list-style-type: none"> <li>• Plug &amp; play for commissioning (same cable for power supply and data transmission)</li> <li>• Touchscreen for simple, intuitive operation</li> <li>• LED lamp on the controllers indicate the valves function and status</li> <li>• Easy integration into new or existing systems</li> </ul>	<ul style="list-style-type: none"> <li>• Easy data evaluation via Master, Hycleen Connect or BMS</li> <li>• Touchscreen for simple, intuitive system operation (no costs for external qualified technicians)</li> </ul>





# Automated system for added safety

Though water suppliers check the quality of drinking water on a regular basis, their responsibility stops at the entrance to the building. Inside the building, the operator is responsible for the quality of the drinking water. Inadequate temperatures, stagnation and biofilm pose the risk of bacterial growth. Keeping this in mind, drinking water installations in buildings must be carefully planned, built and operated.

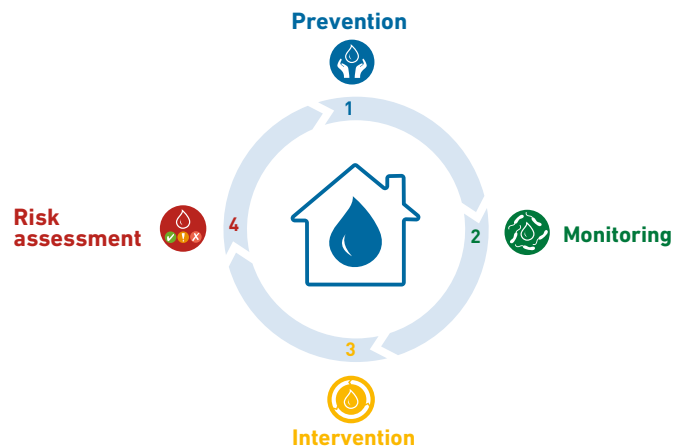
## Hygiene concept

With its Hycleen Automation System, GF Piping Systems assists planners, installation engineers and property operators in a number of ways. The "Hycleen – ensuring optimum drinking water hygiene in four steps" concept illustrates the process. The central data storage and control through the Master, the powerful valves and sensors, as well as the easy-to-operate software and the smart applications make it possible to automate important hygienic measures.



	<p><b>Prevention</b></p>	<ul style="list-style-type: none"> <li>• Adequate circulation in all plant sections</li> <li>• Ensuring the minimum temperature according to the country-specific standard</li> <li>• Constant hydraulic balancing during all operating phases</li> <li>• Regular water exchange through automatic flushing</li> </ul>
	<p><b>Monitoring</b></p>	<ul style="list-style-type: none"> <li>• Continuous temperature monitoring</li> <li>• Measured data storage and logging of the implemented hygiene measures</li> </ul>
	<p><b>Intervention</b></p>	<ul style="list-style-type: none"> <li>• Controlled thermal disinfection can be carried out</li> <li>• Controlled flushing process based on time, temperature or consumption</li> </ul>
	<p><b>Risk assessment</b></p>	<ul style="list-style-type: none"> <li>• Comprehensive database for status and risk assessment</li> </ul>



reddot award 2019



www.gf.com  
GF+  
Model No. 052119301  
Serial No. 39830159  
© 2019 GF+ AG, Switzerland  
GF+ AG, Switzerland

# Applications at a glance



## Hycleen Automation Master

- Just one Master for all applications with intuitive operating concept
- Individually adjustable monitoring and reporting functions with data storage

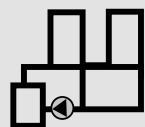

### Hydraulic balancing LegioTherm 2T valve

- Hydraulic balancing for cold and hot water based on temperature or flow
- Thermal disinfection
- Temperature monitoring
- Leakage rate and opening angle adjustable



### Flushing LegioTherm K valve

- Flushing the cold and hot water system based on temperature or time
- Opening angle adjustable



### Actuator automation Uni Controller/Master

- Control and programming of actuators
- Triggers are temperature, sensors, app, alarms



The Hycleen Automation System offers versatile, ready-to-use applications for a safe and hygienically optimized drinking water installation.

All programs and functions can be intuitively operated via the touch-screen on the Hycleen Automation Master. The Master is connected to the controllers, which control the individual valves and sensors. All sensors are permanently monitored, any abnormalities are reported immediately.



**Temperature**  
**T-Sensor**

- All temperatures displayed in realtime
- Clear graphic representation
- All valve temperatures stored in the log



**Flow**  
**Flow sensor**

- Flow displayed in realtime
- Storage of flow and volume



**Maintenance**  
**LegioTherm 2T valve**

- Automatic maintenance once a week
- Prevents jamming or blocking

## Applications

# Hydraulic balancing

The system offers various methods of intelligent hydraulic balancing in order to achieve the best possible solution for every drinking water installation: from dynamic hydraulic balancing, which reacts to usage, to programmable static balancing, where each individual valve automatically adjusts to the optimal leakage rate for the system concerned.

### According to temperature, dynamic



If the water temperature drops below the programmed value, the circulation regulator opens until the desired temperature is reached again. The valve then automatically adjusts to the programmed leakage rate.

- ✓ Responds swiftly to water usage
- ✓ Continuous temperature-controlled balancing ensures constant water temperatures
- ✓ Temperature controlled balancing in both hot and cold water circulation possible

### According to temperature, static



Once a day, the Hycleen Automation Master searches, based on historical temperature data, for the ideal leakage rate of each individual circulation controller. The circulation controllers remain in this position until the next regulation phase. When this happens, the valves open automatically once per phase.

- ✓ Optimum leakage rate of all valves
- ✓ Best possible hydraulic balancing
- ✓ Continuous adjustment to the system

### According to flow, static



Once a day, the Hycleen Automation Master, searches, based on historical flow data, for the ideal leakage rate of each individual circulation controller. The circulation controllers remain in the selected position until the next regulating phase. This function calls for a flow sensor, which is connected to the corresponding circulation controller.

- ✓ Optimum leakage rate of all valves
- ✓ Best possible hydraulic balancing
- ✓ Continuous adjustment to the system

### Fix

The valve does not change the defined leakage rate, and so the opening angle remains in the same position.

- ✓ Central adjustment of the leakage rate via the Master

# Thermal disinfection and automatic maintenance

### Thermal disinfection



An ingenious thermal disinfection process with performance monitoring can be activated if required. The system detects critical temperatures and then goes into thermal disinfection mode. Thermal disinfection occurs in sections, making the process efficient and reducing the energy consumption as well as the required hot water storage capacity.

### Maintenance



An automatic maintenance process, during which each valve is fully opened and closed once, is performed once a week for the circulation control valves. This counteracts any possible adverse effects due to deposits in the circulation lines and on the valves. The mandatory maintenance of the valves is therefore carried out and documented automatically.

## Applications

# Automatic flushing

If water stagnates over a prolonged period, bacteria can multiply in it until a dangerous concentration is reached. If the entire volume in the drinking water distribution system (cold and hot water) is exchanged within three days, the bacteria are flushed out of the drinking water installation and a high bacteria concentration can be counteracted in a sustainable way. The Hycleen Automation System enables automatic flushing of cold and hot water supply lines based on temperature, time or consumption. Each flushing process is recorded and logged.

### Temperature-controlled flushing



As soon as the threshold temperature at the temperature sensor of a flushing valve is exceeded (cold water) or undershot (hot water), the flushing valve opens. It closes again after the pre-programmed time, based on temperature or according to a volume individually defined for each flushing valve.

- ✓ Prevention of critical temperatures in the drinking water installation being exceeded or undershot

### Time-controlled flushing



All flushing valves open sequentially as soon as the preset time is reached. They close after the defined flushing period or according to a volume individually defined for each flushing valve. The time interval between two flushing cycles can be set at will, so that several flushing cycles per day are possible.

- ✓ Ensuring regular water exchange

### Consumption-controlled flushing



A target water volume to be exchanged in a definable period is set for each flushing valve. The Hycleen flow sensor, which is connected to the flushing valve, records the effective water consumptions at time intervals. At the end of the period, only the difference between target and effective water consumption is flushed. A safety flush volume, which is flushed at all times, can also be defined.

- ✓ Ensuring regular water exchange with reduced water consumption

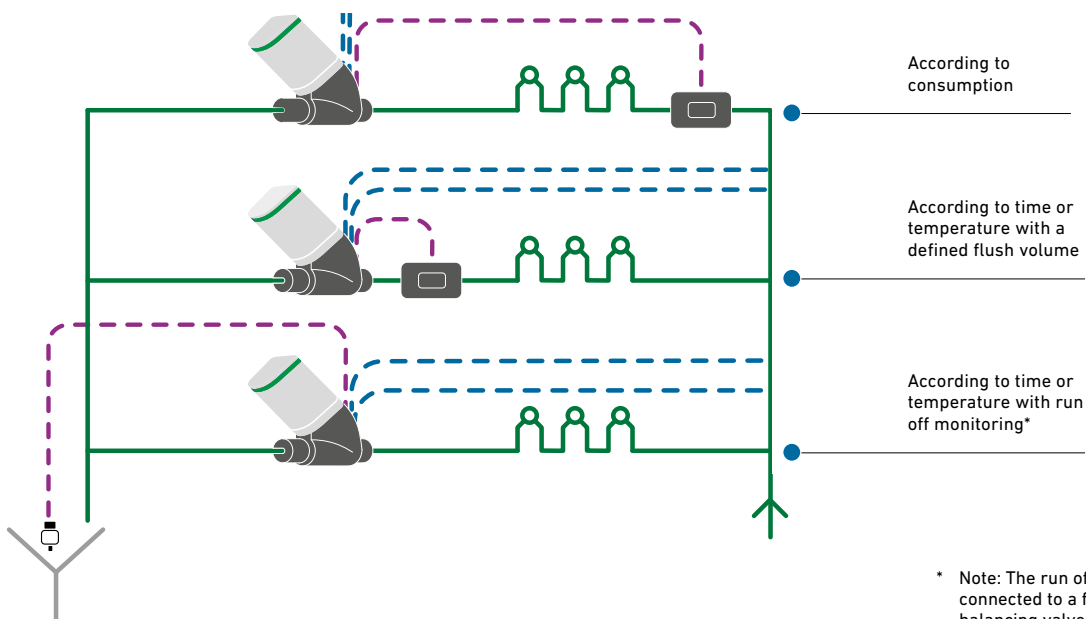

\* Note: The run off monitoring mechanism can be connected to a flushing valve, a hydraulic balancing valve or a Uni Controller.

## Applications

# Actuator automation

Actuators such as servodrives, pumps and many more can be programmed and controlled with ease using Master, relays and Uni Controller. Automated frost protection function, triggering of an electric three-way valve for a thermal disinfection, time-controlled watering of the garden: These are just a few examples to illustrate the benefits of the Hycleen Automation System and its diverse range of applications.

## Automation potentials

In the actuator automation application, various general triggers such as temperature, time or a 4–20 mA signal input, as well as various master-coupled triggers such as thermal disinfection, flushing, maintenance process or alarms can be programmed.

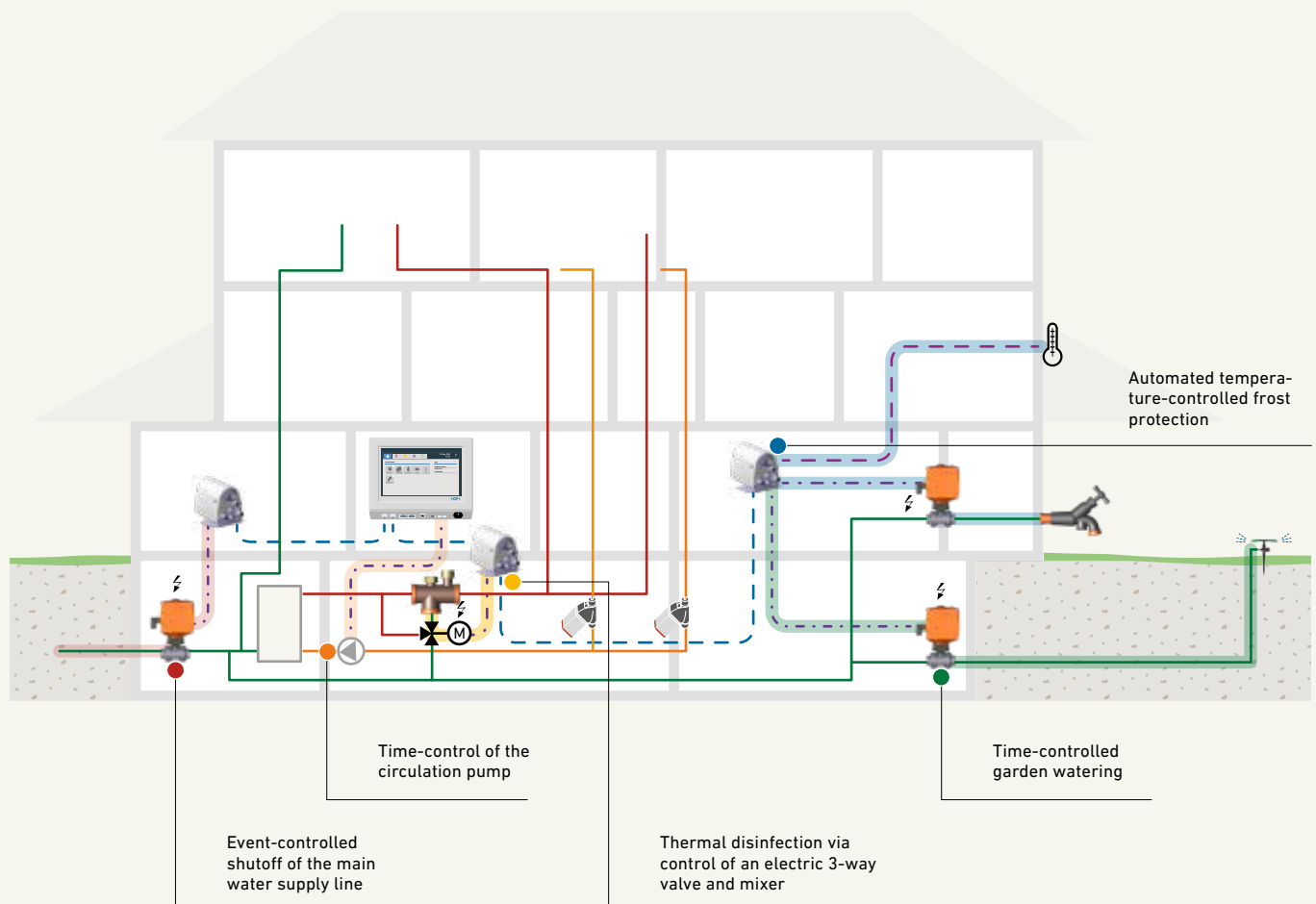



# Installation diagram

### System components



**LegioTherm 2T**  
Valve for hydraulic balancing



**LegioTherm K**  
Flushing valve



**Uni Controller**



**T-Sensor**  
Temperature measurement



**Flow sensor**

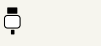

**Run off monitoring system**



**Master**

--- Sensor cable

--- Power supply and communication cable

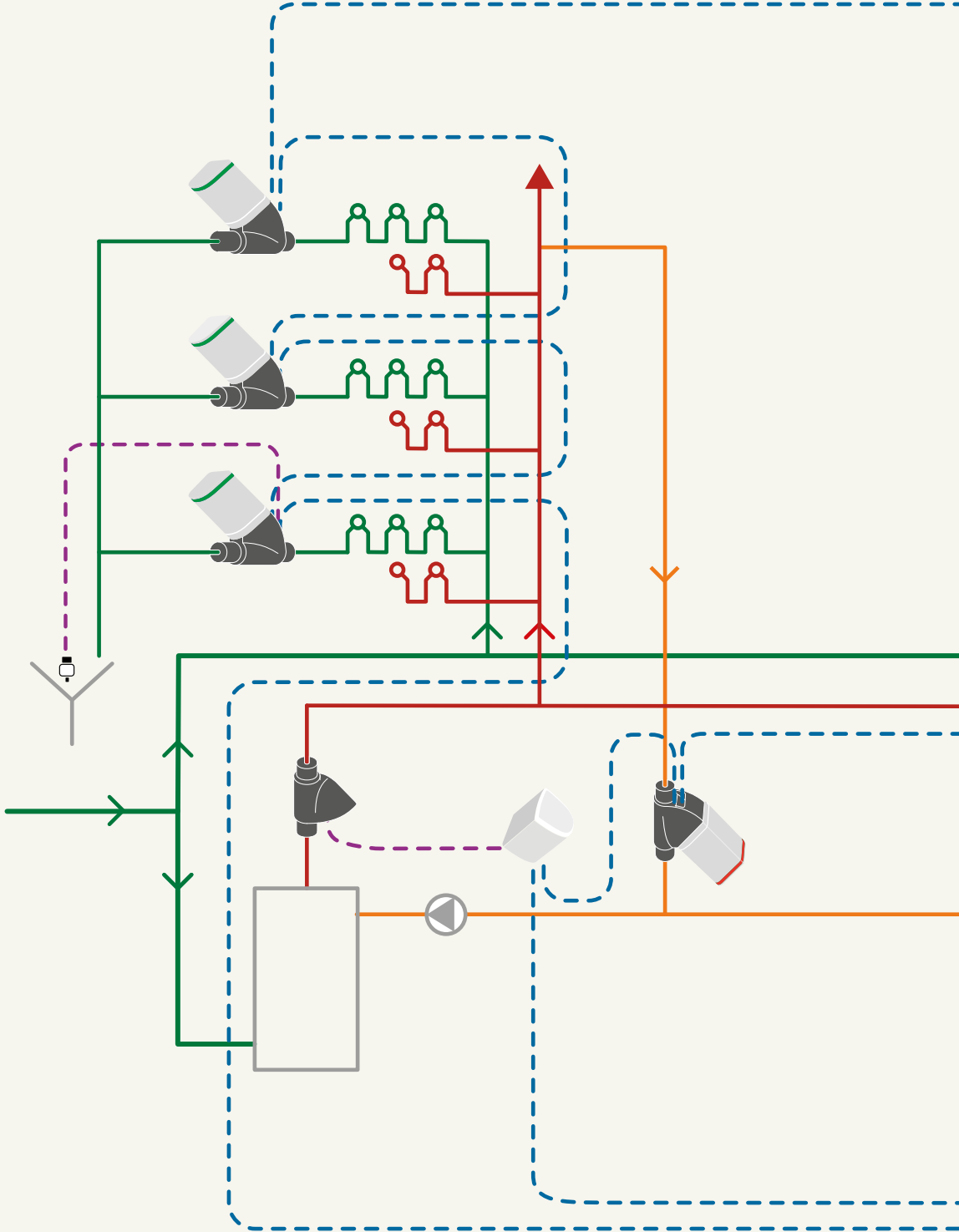

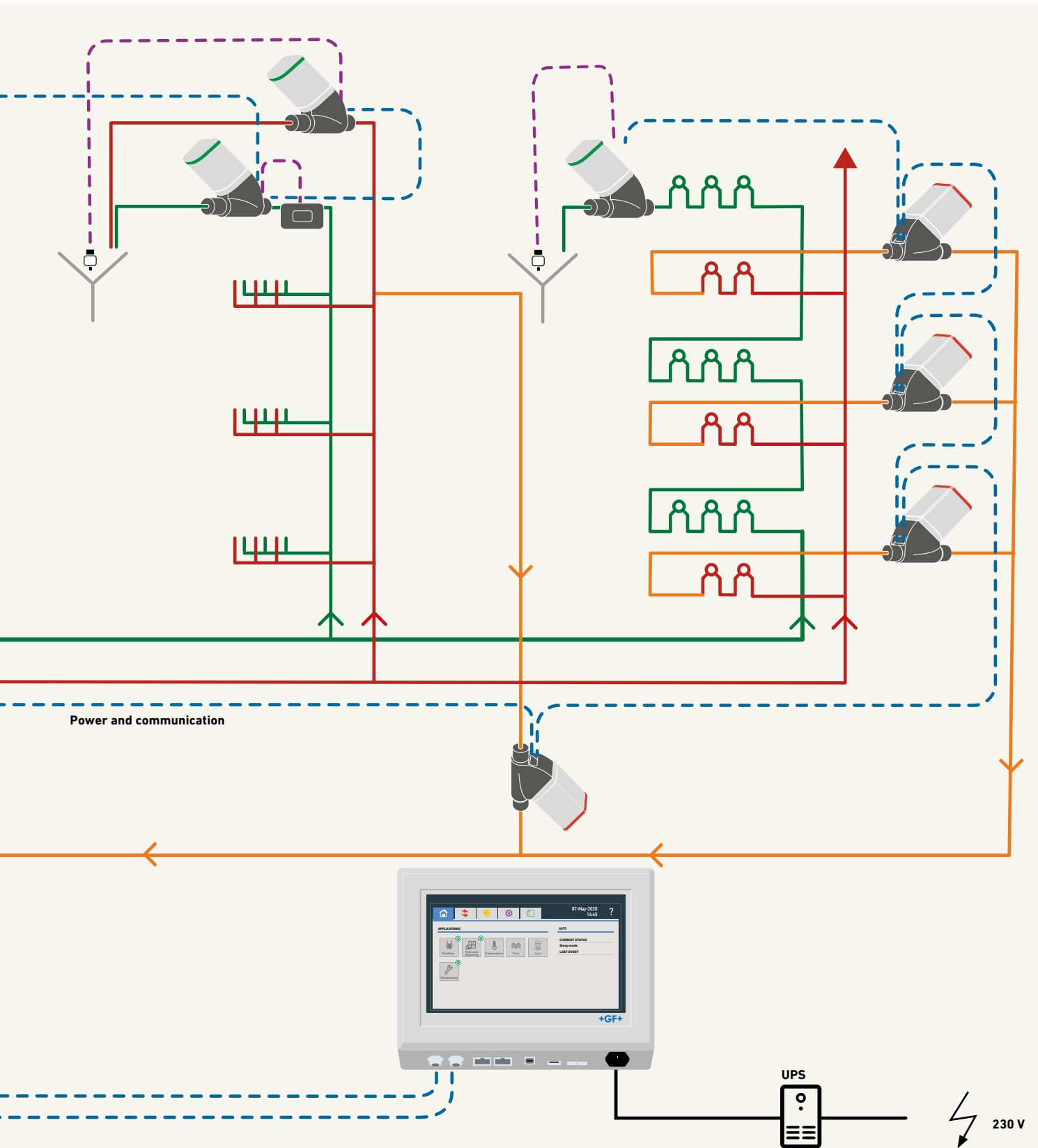

# Cold water circulation

## System components



Heat exchanger



**LegioTherm 2T**  
Valve for hydraulic balancing



**LegioTherm K**  
Flushing valve



**T-Sensor**  
Temperature measurement



Uni Controller



Run off monitoring system



Master

---  
Sensor cable

---  
Power supply and communication cable

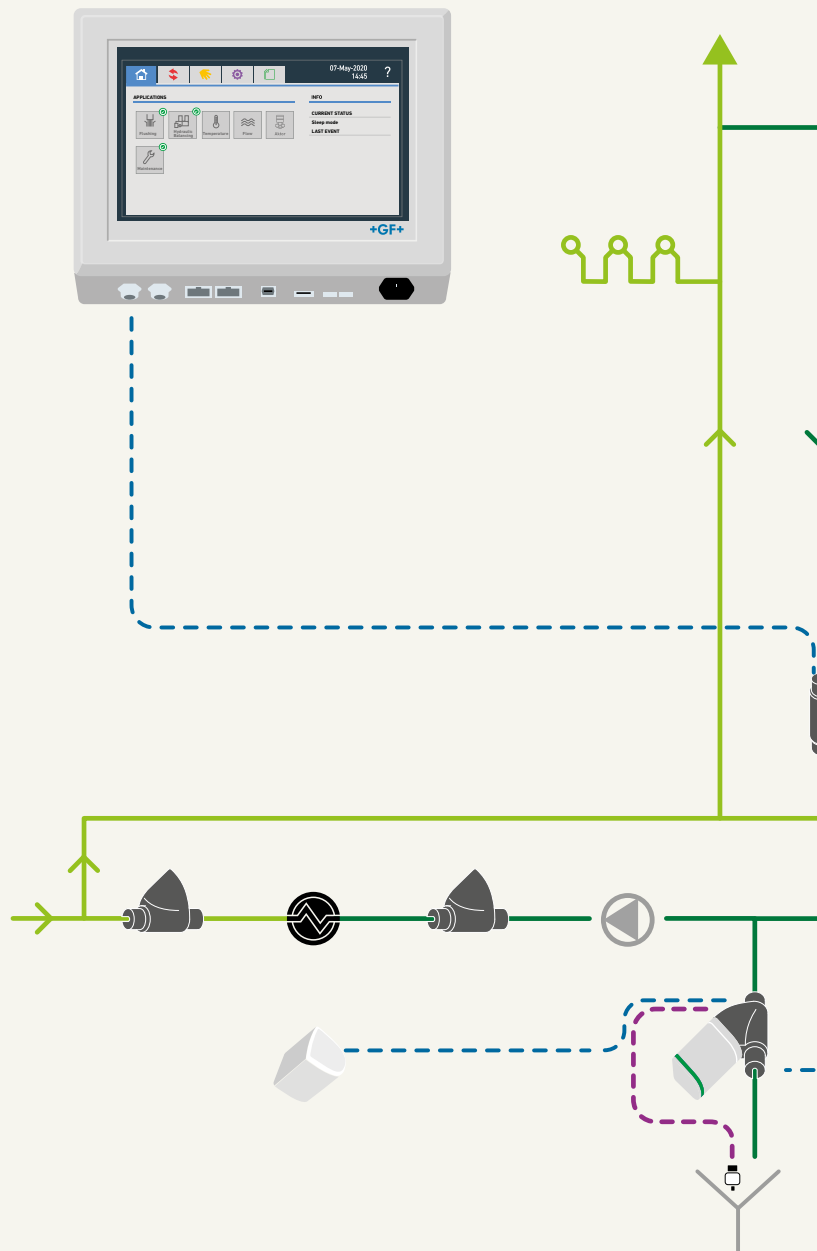



Cold water can be heated up to a hygiene-critical level through internal (hot water for example) and also external thermal loads (hot summer months). This problem can be sustainably resolved by circulating the cold water with faultless hydraulic balancing and property-specific accompanying measures, such as active cooling of the cold water or temperature or time controlled flushing. The balancing valves for an optimal hydraulic system with temperature monitoring in the cold water circulation and flushing valves ensure a regular water exchange.

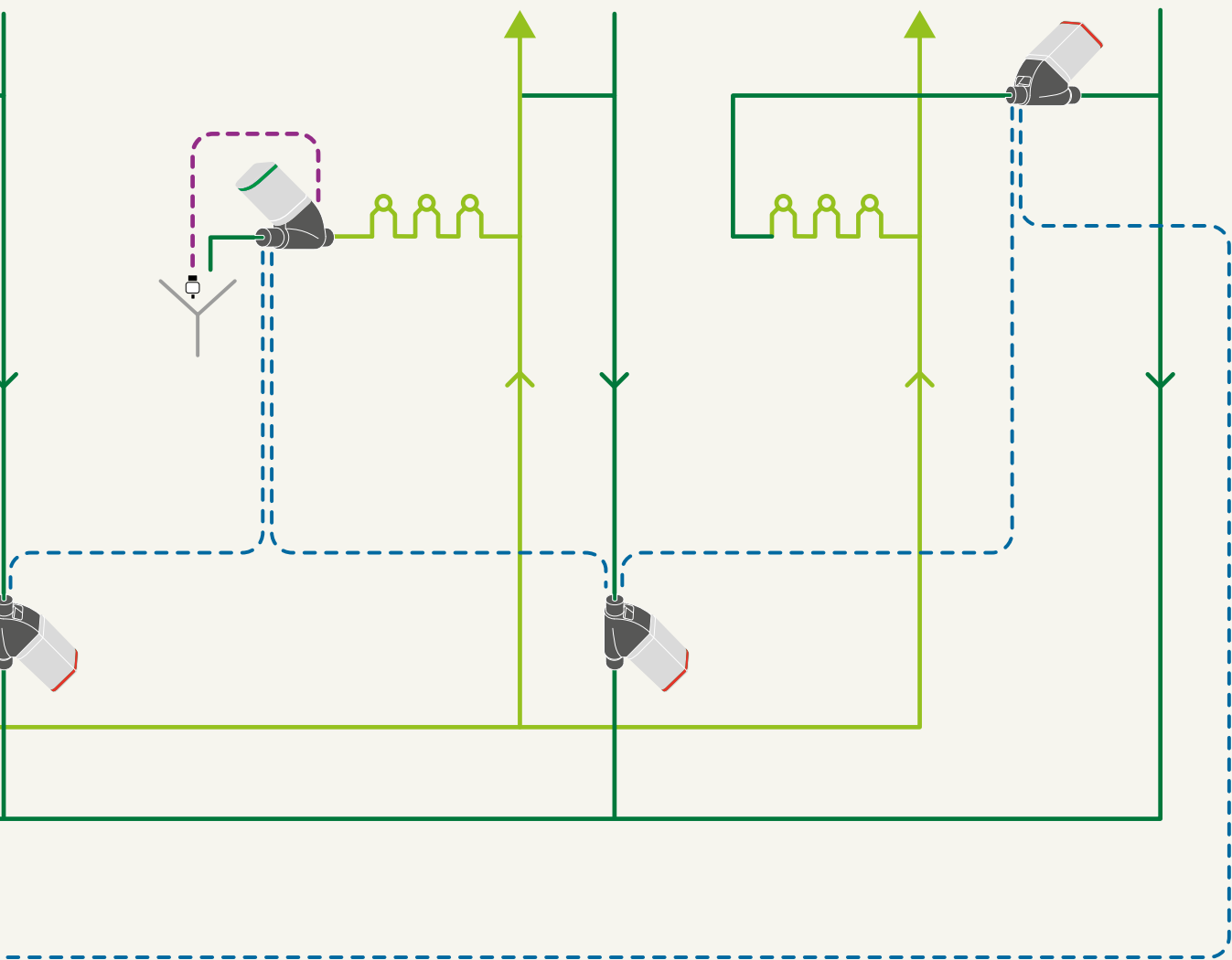

## Hardware

# The Master

The Hycleen Automation Master assumes the central control of up to 50 controllers at two cable sections (each 500 m).

During the commissioning procedure, the Master automatically detects the ID and type of all valves and sensors and it assigns them to the suitable applications.

With predefined values, the system is ready to start immediately. However, all parameters can also be conveniently adapted to individual needs.

### Applications

Flushing, hydraulic balancing, temperature, flow, actuator automation, maintenance

Additional information

### One cable for power supply and data transmission

The pre-assembled Hycleen Automation power supply and communication cables are available in several lengths. The cables can be easily extended by means of suitable cable couplings. When connecting the cable to the valve, the valve automatically detects input and output.



### Running application

The current values of the connected valves and sensors are displayed in realtime.

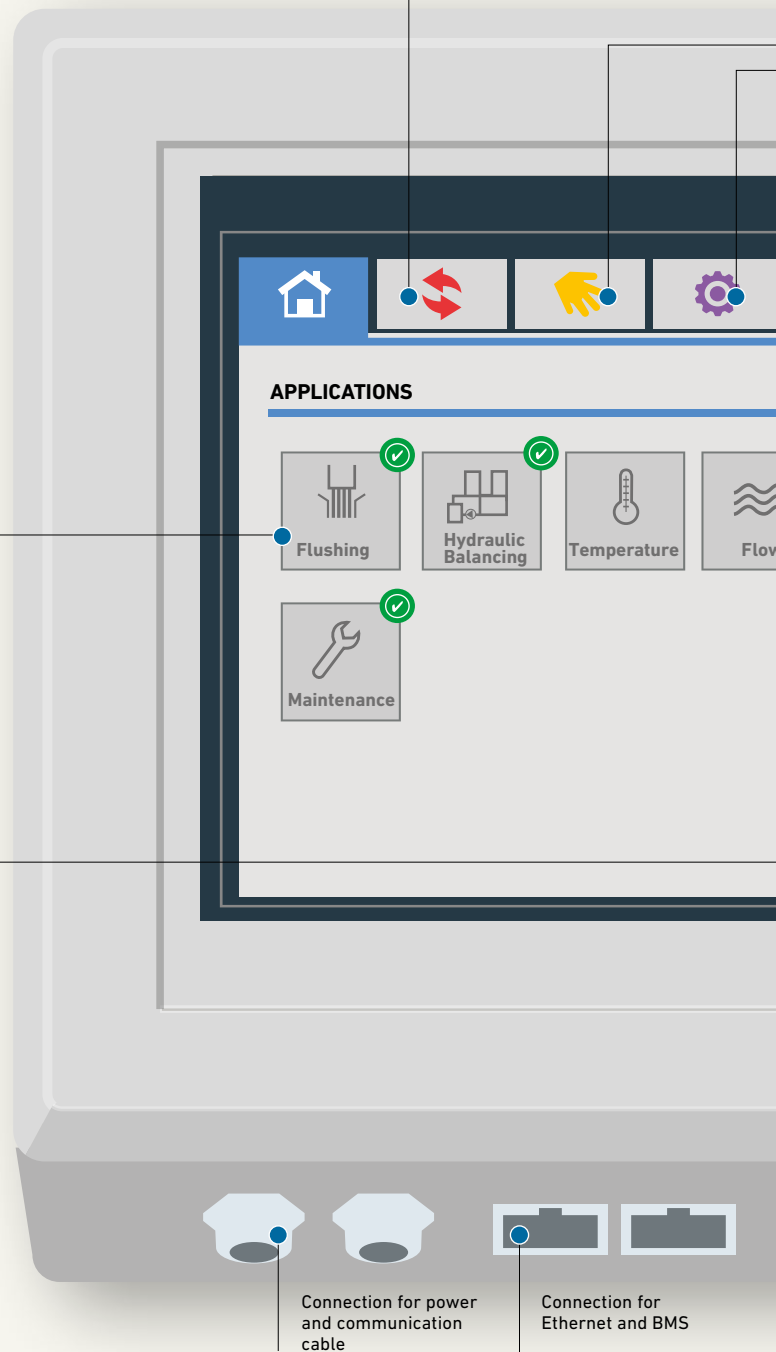

Connection for power and communication cable

Connection for Ethernet and BMS



**Manual mode**

All valves and sensors can also be controlled directly.



**Settings**

System parameters (date, time, units of measure and language) can be adjusted at any time.



**Logs**

Automatically created logs, for temperature profile or thermal disinfection for example, can be displayed and retrieved.

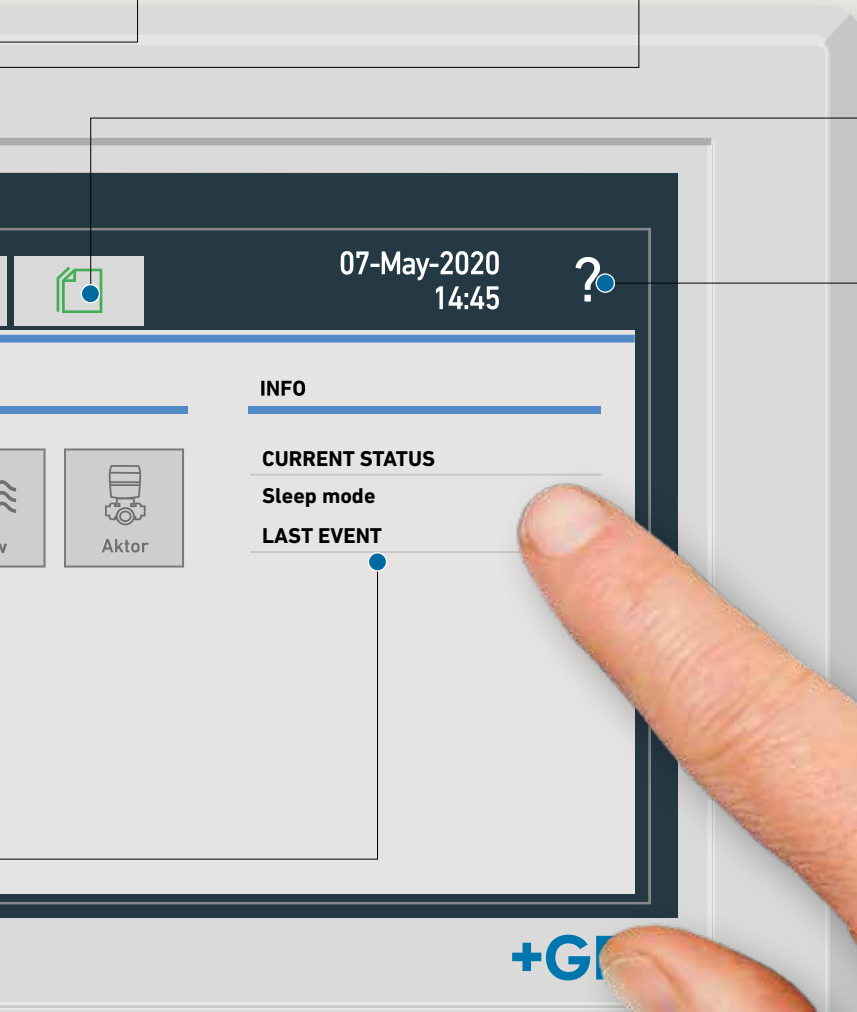

Context-sensitive help



USB connection



Floating contact connection



Power connection 230 V

+GF

## Hardware

# The Uni Controller

The Uni Controller is the universal connection box for the Hy-clean Automation System. It permits the connection of two sensors from the range and the control of motors, three-way valves, circulation pump and valves via its relay and 4–20 mA inputs/outputs. Control is either manual via the Master or automated. It is therefore possible to control a three-way valve to carry out a thermal disinfection, to automate frost

protection or external watering, to control a valve for an action or to integrate sensors that deliver a 4–20 mA signal.

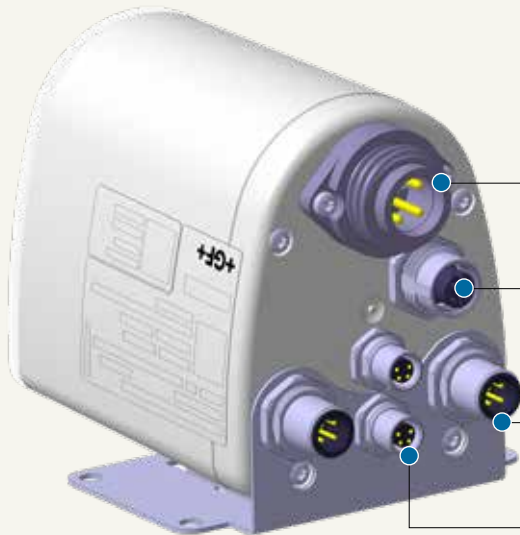

### Relay 24V/230V

Control of relays for connecting external actuators, with associated cable

### 4–20 mA IN/OUT

Control of servodrive (valve) with position drop info, with associated cable

### Quick, error-free wiring

Automatic detection of input and output during commissioning

Series wiring with valves

### 2 connections (M8) for external sensors

4–20 mA, pulse, 0/1 input, connected directly to the Uni Controller

### Mounting

On the wall or pipe

### Activity display (LED ring)

Color of the LED ring depends on the valve - red (LegioTherm 2T), green (LegioTherm K) or white (Uni Controller)  
Valve status (open/closed)

### Peelable label

With valve ID and QR code with additional information



## Hardware

# The valve

The LegioTherm 2T and LegioTherm K valves, together with the Master, are at the heart of the Hycleen Automation System. They constantly measure the water temperature and relay the values to the Master. The valve functions are activated by the Master based on set parameters. During commissioning, the Master detects all valves based on their ID.

### LegioTherm 2T circulation valve

- Leakage rate and maximum opening angle adjustable
- Higher linearity and more precise regulation thanks to special conical profile
- Application: hydraulic balancing, thermal disinfection, temperature monitoring, maintenance (once a week)

### LegioTherm K flushing valve

- Adjustable valve stroke: Flow rate with valve open
- Application: Flushing of cold or hot water installations based on temperature or time

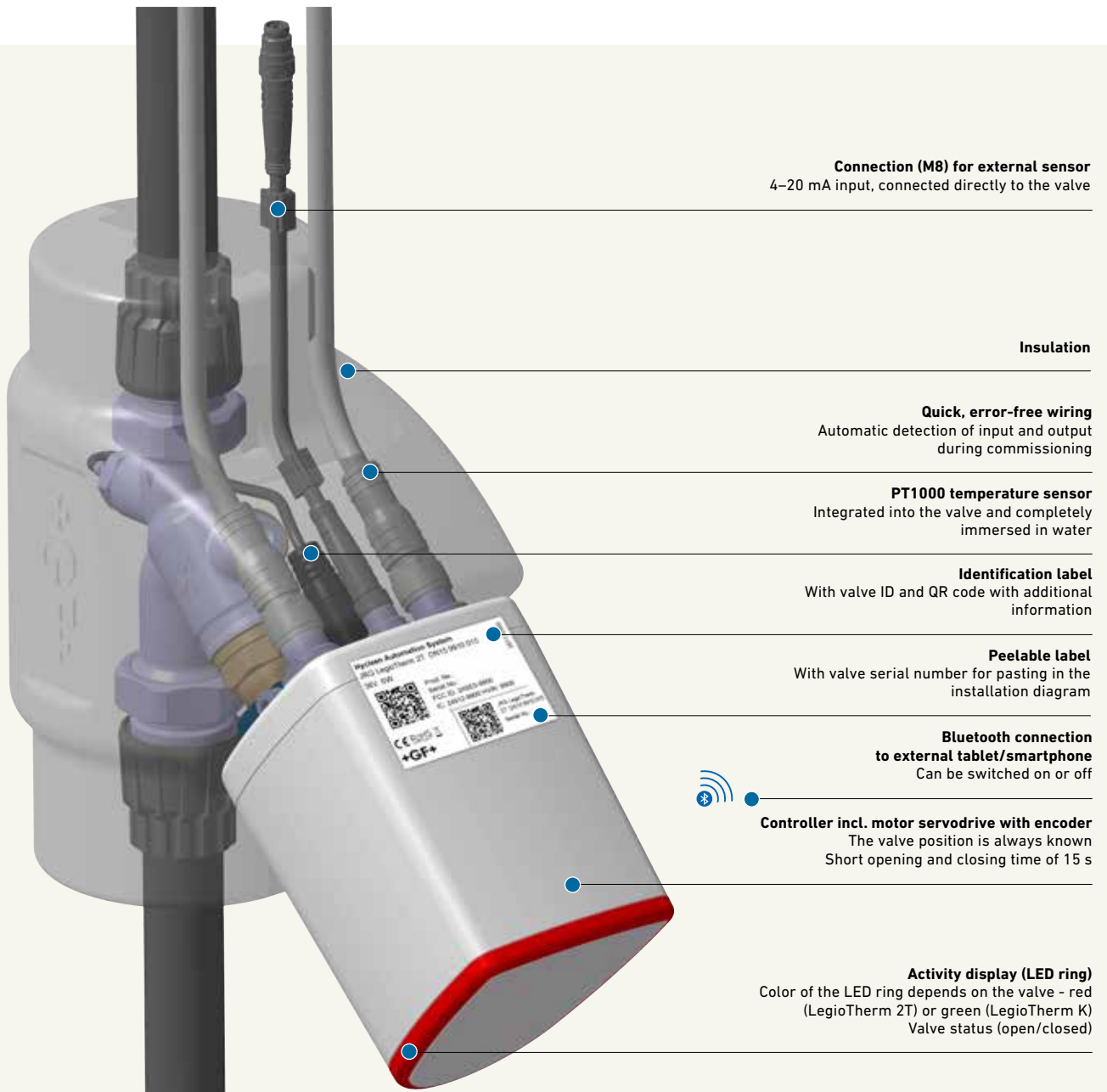

**Connection (M8) for external sensor**  
4–20 mA input, connected directly to the valve

**Insulation**

**Quick, error-free wiring**  
Automatic detection of input and output during commissioning

**PT1000 temperature sensor**  
Integrated into the valve and completely immersed in water

**Identification label**  
With valve ID and QR code with additional information

**Peelable label**  
With valve serial number for pasting in the installation diagram



**Bluetooth connection to external tablet/smartphone**  
Can be switched on or off

**Controller incl. motor servodrive with encoder**  
The valve position is always known  
Short opening and closing time of 15 s

**Activity display (LED ring)**  
Color of the LED ring depends on the valve - red (LegioTherm 2T) or green (LegioTherm K)  
Valve status (open/closed)

## Hardware

# The sensors

All sensors are automatically detected and monitored by the Master.

### T-Sensor

The external temperature sensor monitors temperatures at additional points, for example at the input/output of the water heater.

### Flow sensor

The flow sensor is connected to any Hyclean Automation valve or to a Uni Controller. It measures the volume and the flow rate of the water. Connected to a circulation controller,

this triggers a static hydraulic balancing process after a set flow rate, depending on the programming. However, the sensor can also be used to simply display the flow.

### Run off monitoring system

The run off monitoring function improves the safety of the flushing process. It is inserted into the drain line and connected to a valve or to the Uni Controller. The safety element triggers a signal when the water level rises significantly, this causes the flushing process to be interrupted or an action to be initiated by the actuator application.

### Flow sensor

**M8 plug**  
Connection to a Controller,  
automatic type recognition by the  
Master



**Flow sensor**  
Measurement of flow  
and speed

**Flow bolts**

### T-Sensor

Dimensionally-independent or with gunmetal housing

**T-Sensor**  
Temperature  
monitoring



**M8 plug**  
Connection to a  
Controller, automatic  
type recognition by the  
Master

### Run off monitoring system

**M8 plug**  
Connection to a  
Controller,  
automatic type  
recognition by the  
Master

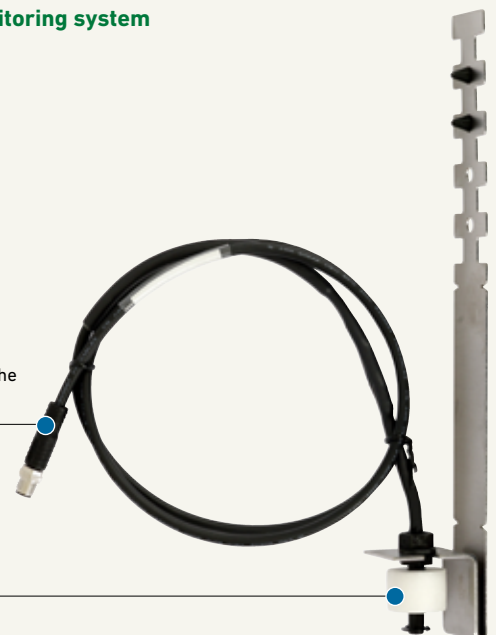

**Float switch**

# Made for you



The image shows a hand pointing at a computer monitor. The monitor displays a technical interface with a table of temperature values. The table has two columns: 'Name' and 'Value'. The 'Name' column contains several entries starting with 'therm'. The 'Value' column contains temperature values in degrees Celsius. The interface also includes a header 'Hydraulic alignment' and a 'me' button.

Name	Value
therm	
therm	53°C
therm	56°C
therm	57°C
therm	57°C
therm	56°C

Digital marketplace

# CONNECT platform

Thanks to the new digital marketplace, you can register your Hycleen Automation System installations, save your Master configurations and acquire additional Master functions (modules), such as Hycleen Connect remote access or an interface to the building management system.

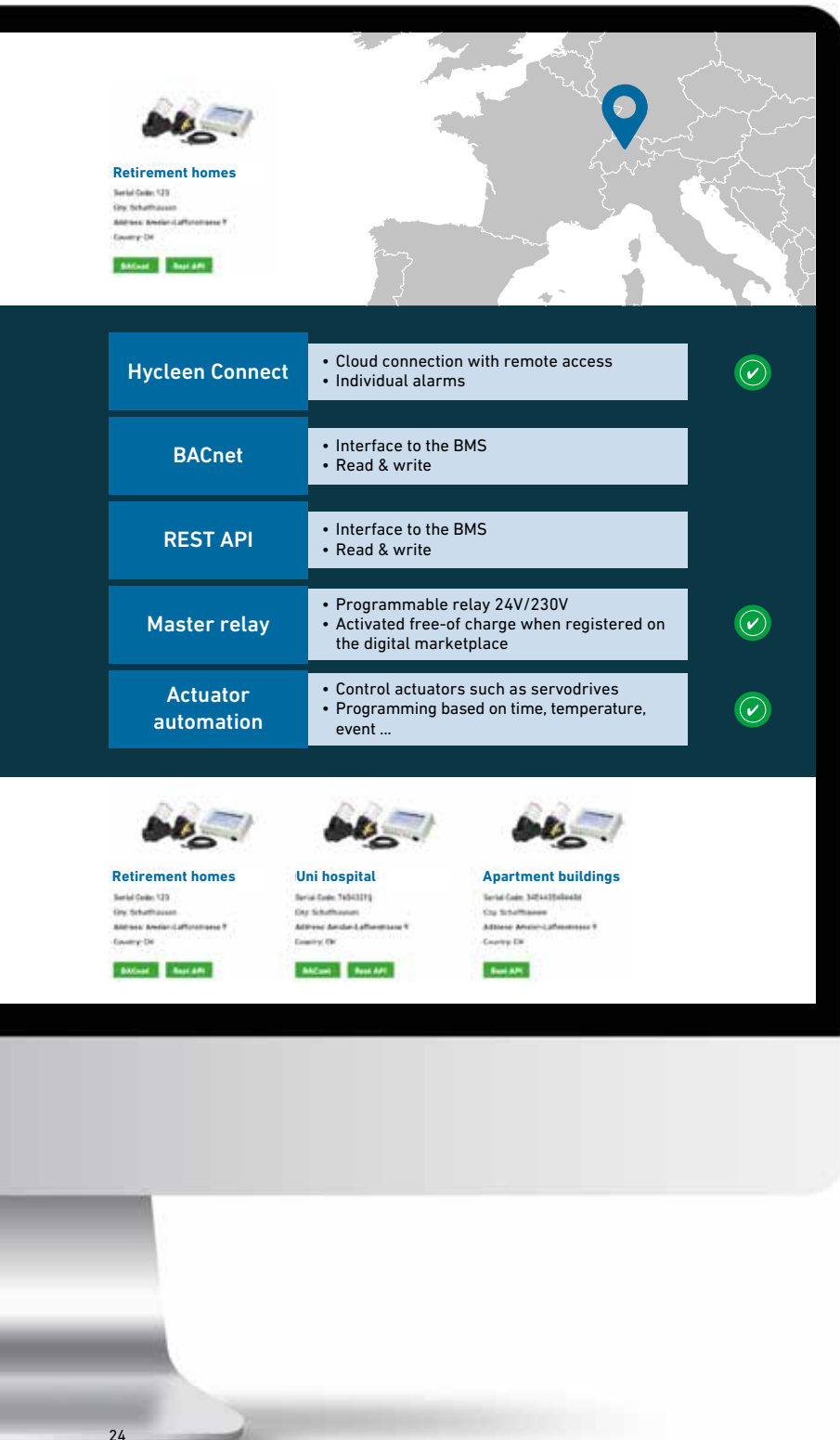

**1.**  
**Register your Hycleen Automation System installations**

**2.**  
**Select your modules**

**3.**  
**Download the licenses for your Master and save your Master backup**



# Hyclean Connect

Hyclean Connect is the innovative solution for a secure connection and remote access to the Hyclean Automation System from anywhere in the world. Connected drinking water installations can be conveniently controlled and monitored. Reporting and alarm systems help ensure system operability and highlight optimization potential. In case of problems, the GF Service technician provides support via remote access.

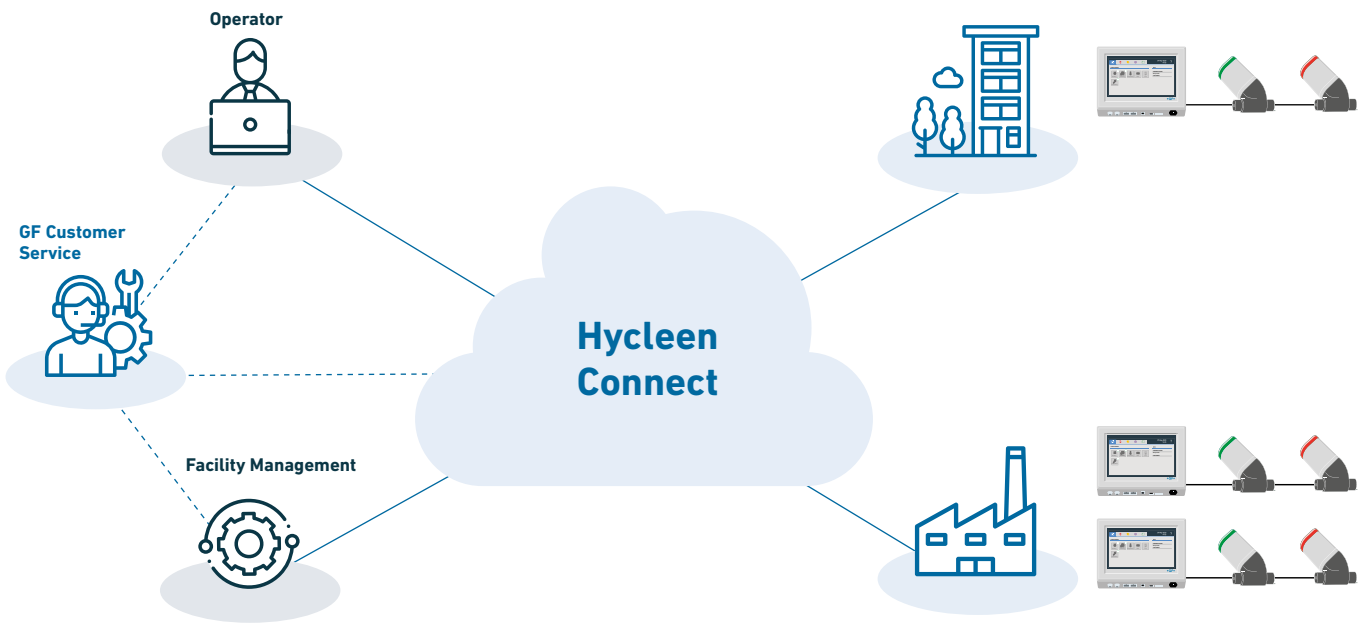

## Benefits

- Online data storage
- Easy report creation
- Asset Management
- Everything in one place

- User-specific setup according to limit values or events
- Automatic notification

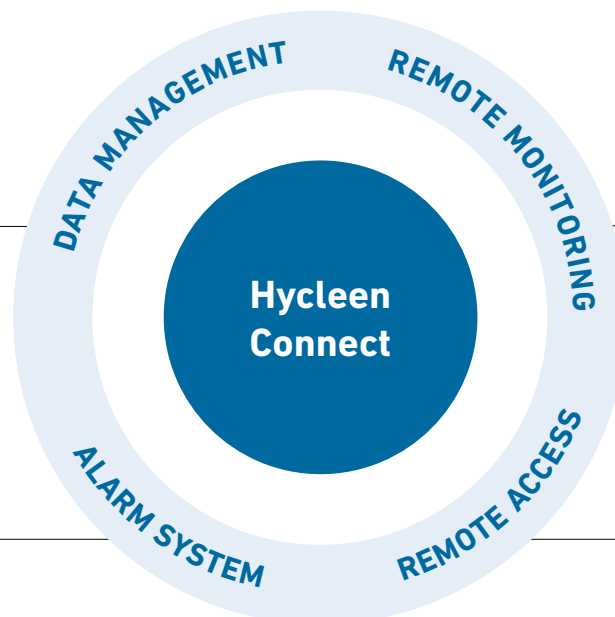

- Online display of values in realtime or historically
- Clearly arranged dashboards
- Status of the installations at a glance

- Secure access to process data
- Online adjustment to parameters

## Data management

# Logging

The logs show the most important information from the system in a clearly arranged manner. As well as providing valuable insights into the system's status and optimization potentials, the logs also demonstrate compliance with the hygiene regulations.

The Hyclean Automation Master logs the temperature of all valves and also provides pre-programmed reports, which show the measured data in a clearly arranged manner. Even lay-people can easily read off trends and respond to abnormalities without delay.

### Pre-programmed reports

The following reports are available:

- Hydraulic balancing
- Flushing
- Manual operation
- Maintenance

The hydraulic balancing log includes the application settings, the temperature profiles of the individual valves during the log period, limit value overruns and valve settings.

The time period for a report can be selected: a day, a week or a month. The data are evaluated for each individual valve and the most important information presented as a clearly structured table or diagram. All reports can be exported in PDF and XML formats. The information is presented at three levels in various degrees of detail.

### Logging temperature and flow

Temperature monitoring is the most important instrument for property operators to assess the hygiene situation of the drinking water installation and to reliably and quickly detect risks. A written record shows that all the measures required to achieve a hygienic cold and hot water supply in the building have been implemented. The temperature values can be saved every 5, 15, 30 or 60 minutes, depending on the degree of accuracy required.

**Hyclean Automation System** +GF+

**LOG - Hydraulic balancing** Log number 113

Application name	Hydraulic balancing	<table border="1" style="width: 100%; border-collapse: collapse;"> <tr> <td style="width: 30%;">Object</td> <td>Master Labor JRG</td> </tr> <tr> <td>Name</td> <td>Hauptstrasse</td> </tr> <tr> <td>Street</td> <td>SISSACH</td> </tr> <tr> <td>PLZ/City</td> <td></td> </tr> </table>	Object	Master Labor JRG	Name	Hauptstrasse	Street	SISSACH	PLZ/City	
Object	Master Labor JRG									
Name	Hauptstrasse									
Street	SISSACH									
PLZ/City										
Period	13 - Jan - 2020 - 14 - Jan - 2020									
Log created	14 - Jan - 2020									

**Process**

Type	Range	Temperature-Hydraulic balancing	Lower temperature limit	Upper temperature limit
Temperature	Hot	57°C	45%	90°C

**Hyclean Automation System** +GF+

**Overrun of limit temperatures**

Valve number	Below limit		Limit exceeded	
	Quantity	Duration [hh:mm:ss]	Quantity	Duration [hh:mm:ss]
1	0	00:00:00	0	00:00:00
2	0	00:00:00	0	00:00:00
3	0	00:00:00	0	00:00:00
4	0	00:00:00	0	00:00:00
5	0	00:00:00	0	00:00:00
6	0	00:00:00	0	00:00:00
7	0	00:00:00	0	00:00:00
9	0	00:00:00	0	00:00:00
10	0	00:00:00	0	00:00:00
11	0	00:00:00	0	00:00:00

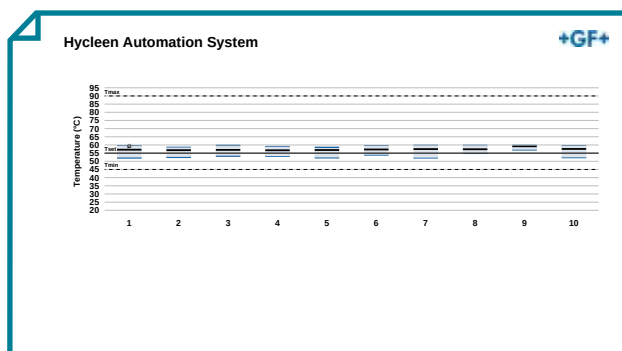

**Hyclean Automation System** +GF+

Valve number	Name	Serial number	Leakage rate	Max. opening angle
1	DN15 2T - 20m	002310	14%	50%
2	DN15 2T - 50m	002308	9%	70%
3	DN15 2T - 200m	001599	10%	70%
4	DN15 2T - 50m(2)	002331	14%	70%
5	DN15 2T LF - 10m	002160	14%	70%
6	DN25 2T LF - 20m	002253	5%	70%
7	DN20 2T LF - 20m	002309	7%	70%
9	Legiotherm	0003684	25%	70%
10	Nr 12	0002897	20%	70%

## Data management

# Building management system

For building automation, two interfaces to the Master are available for data communication: BACnet IP (Building Automation and Control networks) and REST API (Representational State Transfer Application Programming Interface). Both interfaces permit a connection to the building management system (BSM) with read and write privileges. BACnet works with conventional BSM programs. REST API is the interface of the future.

The following Hycleen Automation System data can be exported from the higher-level BMS by acquiring a license.

### Options

- Realtime data monitoring
- Logging
- Alarm management

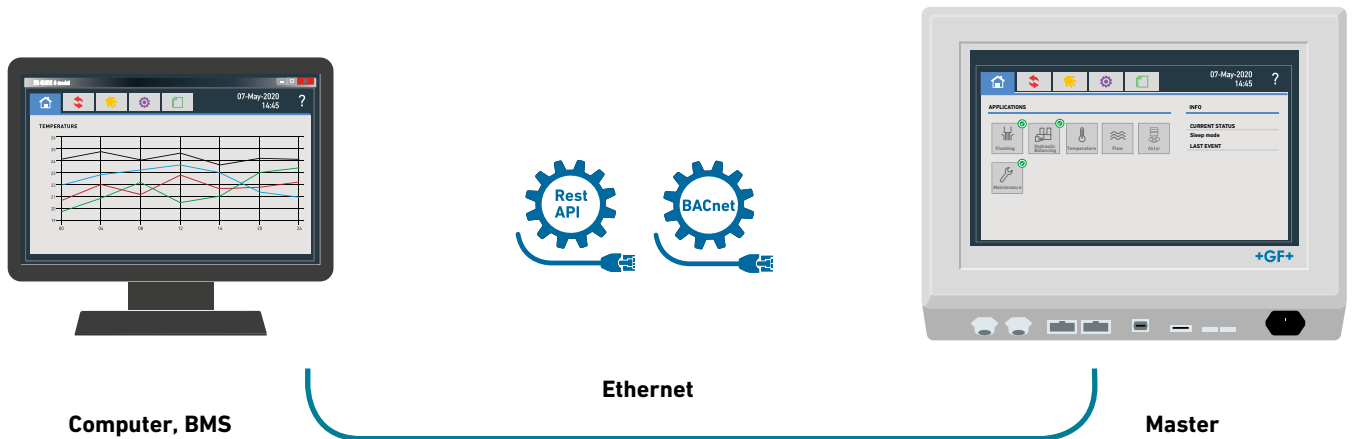

## App

The app allows data from the Hycleen Automation System to be conveniently requested from a smartphone. The app connects to the desired valve in the vicinity via Bluetooth, so the data in the Master is accessible immediately (read privileges only). You no longer have to go to the office or equipment room.



## Technical specifications

# Nomogram JRG LegioTherm K

Flushing capacity DN15

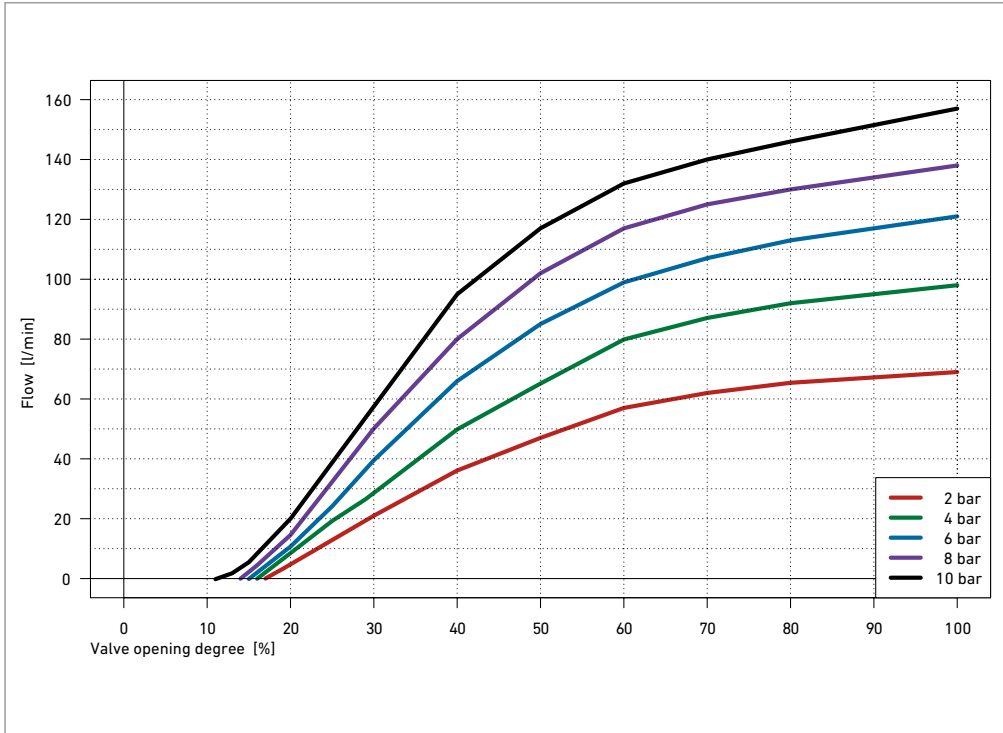

Flushing capacity DN20

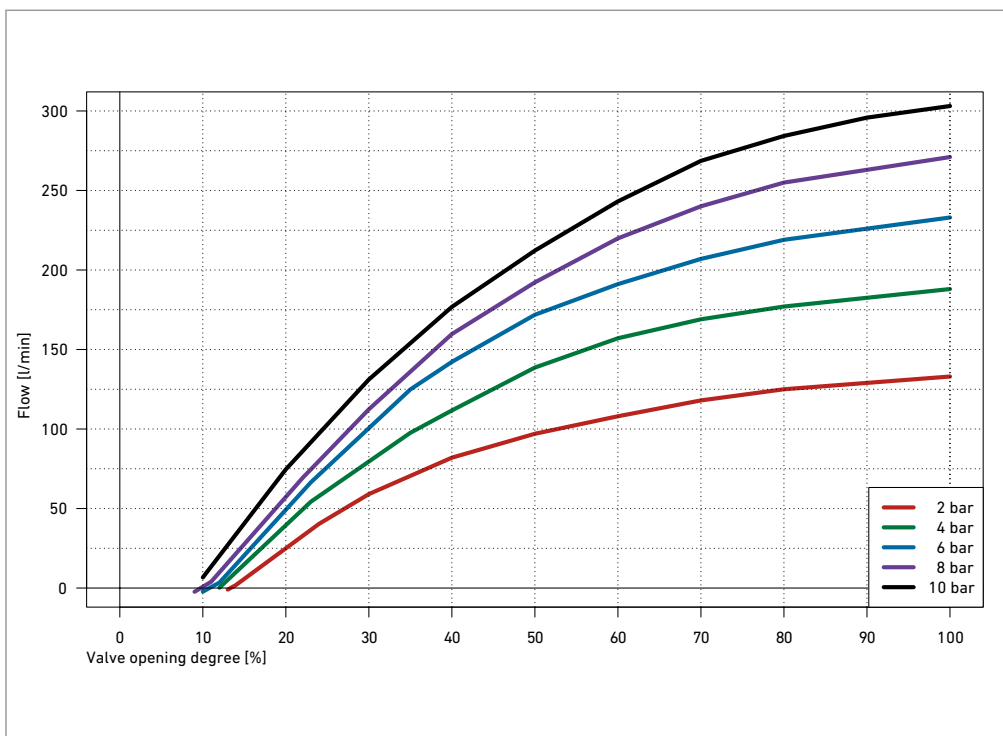

Technical specifications

# Nomogram JRG LegioTherm 2T

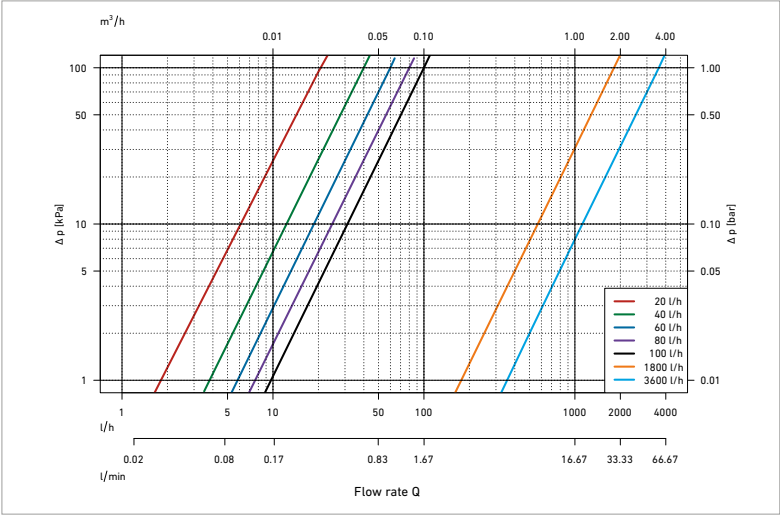

Pressure loss DN15

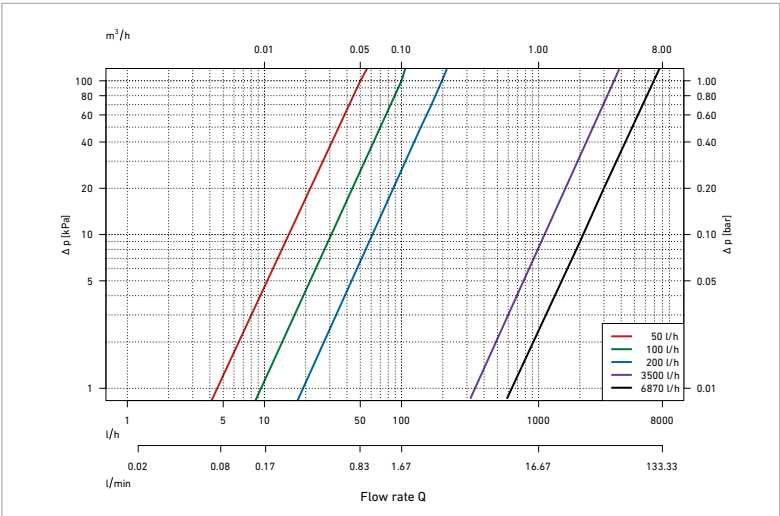

Pressure loss DN20

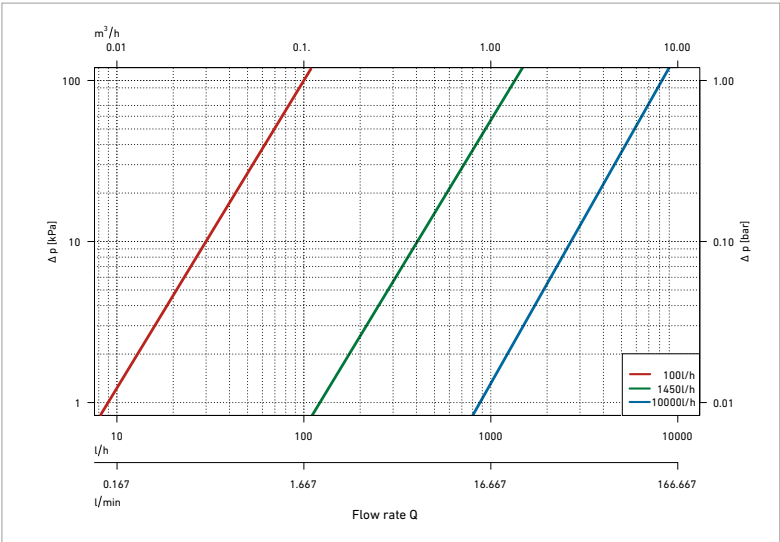

Pressure loss DN25

# Nomogram JRG LegioTherm 2T

Characteristic curve for valve opening angle

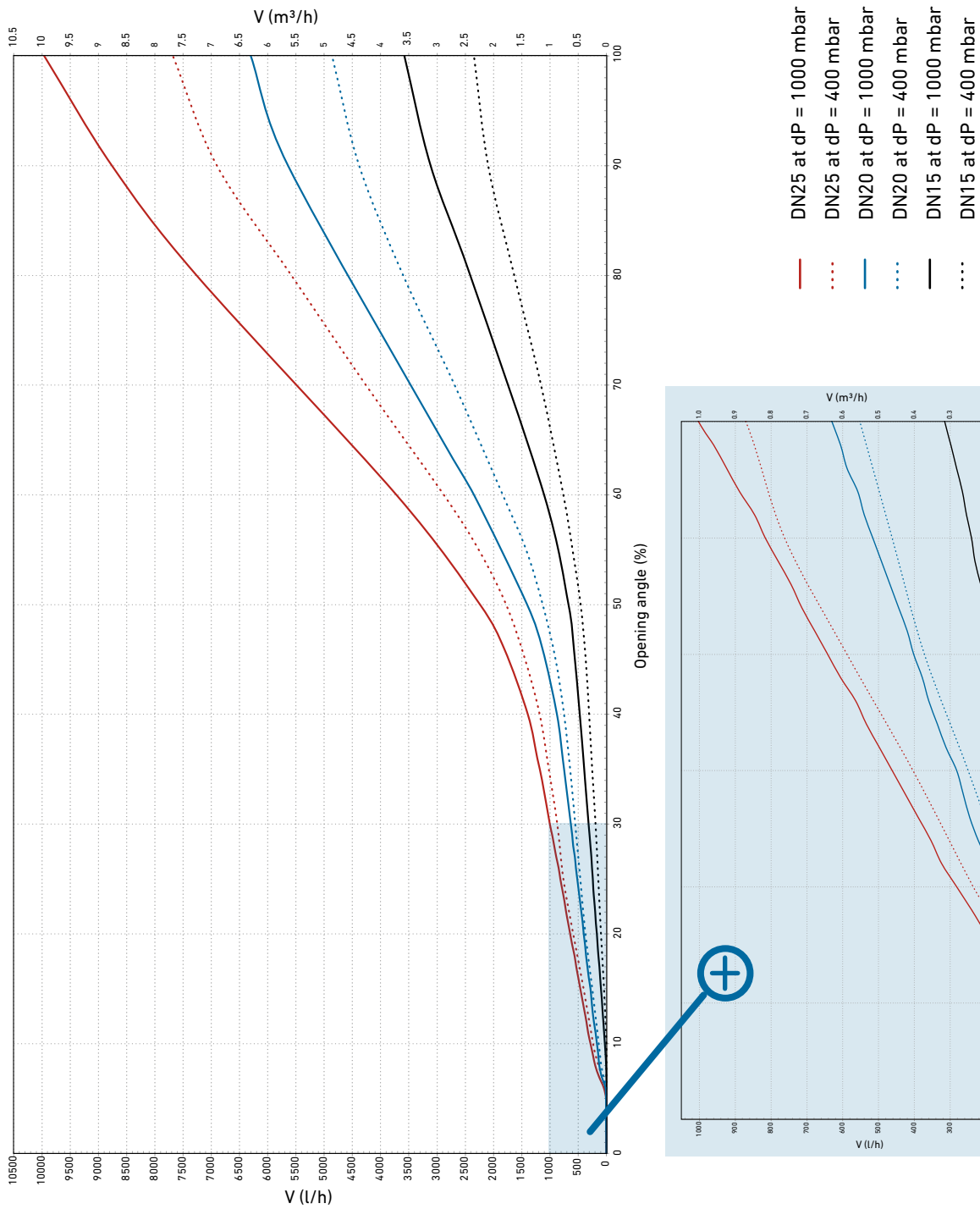

# Products



### Hycleen Automation Master

- Description: master for max. 50 controller
- Consisting of: touchscreen 10.1", power supply, bluetooth connection, 2 plugs M12 for 2x 300m cable (500m with powerbox), 2 Rj45 jacks (Ethernet), 2 USB connections (read/write), USB jack (read only), relay output, screw set

Voltage	JRG Code	GF Code	Weight (kg)	l (mm)	b (mm)	h (mm)	Version
230V / 36V	<b>9900.000</b>	<b>351 110 656</b>	2.300	326	84	214	EU
230V / 36V	<b>9900.001</b>	<b>351 110 655</b>	2.300	326	84	214	CH
230V / 36V	<b>9900.003</b>	<b>351 110 679</b>	2.300	326	84	214	UK

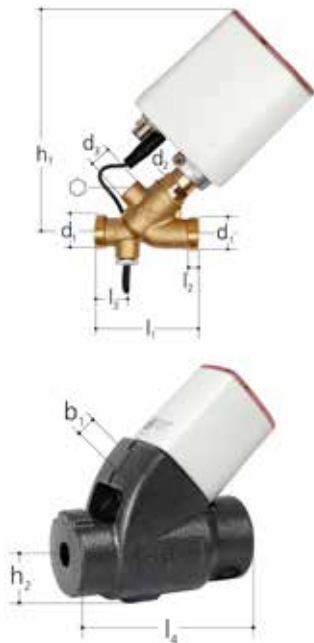

### JRG LegioTherm 2T Circulation valve with controller, PN 10

- Temperature: max. 90°C
- Material: gunmetal, stainless steel, EPDM
- Factory setting: 57°C (adjustable 0 - 90°C) thermal desinfection 70°C (adjustable 60 - 90°C)
- Connection: male thread (for union connection with flat gasket)

DN (mm)	JRG Code	GF Code	Weight (kg)
15	<b>9910.015</b>	<b>351 110 550</b>	0.820
20	<b>9910.020</b>	<b>351 110 590</b>	1.050
25	<b>9910.025</b>	<b>351 110 630</b>	1.400

DN (mm)	d1 (inch)	G (inch)	d2 (inch)	d3 (inch)	Rp (inch)	l1 (mm)	l2 (mm)	l3 (mm)	l4 (mm)	b (mm)	h1 (mm)	h2 (mm)	⊘
15	3/4	1/2	3/4	3/4	75	6	24	173	90	162	50	6	6
20	1	3/4	3/4	3/4	87	7	24	206	92	169	54	6	6
25	1 1/4	1	3/4	3/4	99	8	24	233	100	179	56	6	6

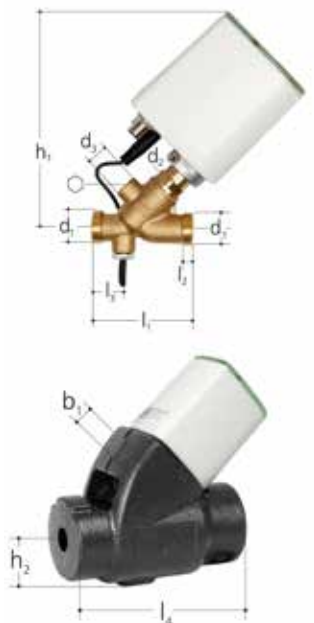

### JRG LegioTherm K Flushing valve with controller, PN 10

- Temperature: max. 90°C
- Material: gunmetal, stainless steel, EPDM
- Factory setting: 20°C (adjustable 0 - 90°C)
- Connection: male thread (for union connection with flat gasket)

\*Note: The JRG LegioTherm K flushing valve must not be used without the consent of the holder of patents EP 1 845 207 B1 and DE 10 2006 017 807 B4 for use in a water system of the type described in these patents.

DN (mm)	JRG Code	GF Code	Weight (kg)
15	<b>9920.015</b>	<b>351 110 600</b>	0.810
20	<b>9920.020</b>	<b>351 110 610</b>	1.020

DN (mm)	d1 (inch)	G (inch)	d2 (inch)	d3 (inch)	Rp (inch)	l1 (mm)	l2 (mm)	l3 (mm)	l4 (mm)	b (mm)	h1 (mm)	h2 (mm)	⊘
15	3/4	1/2	3/4	3/4	75	6	24	173	90	162	50	6	6
20	1	3/4	3/4	3/4	87	7	24	206	92	169	54	6	6

# Products



### Uni Controller

The Uni Controller is connected in series with the other Hycleen AS Controllers. It allows the connection of two 4-20 mA sensors (external Hycleen AS sensors or sensors of other manufacturers) as well as the connection of actuators via a 24V/230V relay output, and/or a 4-20mA IN/OUT signal. The programming is done via the masters.

- Temperature: ambient temperature 0-45°C
- Raw Material: Plastic
- Connection: 2x M12, 2x M8 for external sensors, 1X M12 4-20mA IN/OUT, 1 x RD 24 (24V/230V relay)



JRG Code	Weight (kg)	GF Code	h (mm)	l (mm)	b (mm)
9902.000	0.4	351 110 645	93	125	90

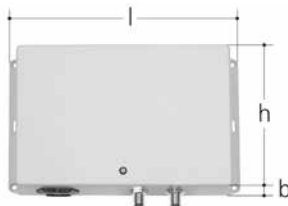

### Hycleen Automation Powerbox

- Description: Power supply of Hycleen Automation System for expansion of 300m cable length to max. 500m per cable line
- Consisting of: 2m power cable, screw set

Voltage	JRG Code	GF Code	Weight (kg)	l (mm)	b (mm)	h (mm)	Version
230V / 36V	9901.000	351 110 626	1.000	244	64	164	EU
230V / 36V	9901.001	351 110 625	1.000	244	64	164	CH
230V / 36V	9901.003	351 110 659	1.000	244	64	164	UK

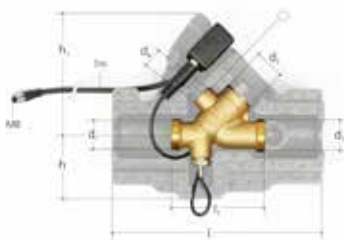

### T-Sensor

- Description: Temperature sensor PT 1000
- Temperature: max. 90°C
- Material: gunmetal
- Connection: male thread, plug M8

d (mm)	JRG Code	Weight (kg)	GF Code	d1 G (inch)	d2 G (inch)	d3 G (inch)	d4 Rp (inch)	l (mm)	l1 (mm)	h (mm)	h1 (mm)
15	9951.015	0.460	351 110 535	3/4	1/2	3/4	1/4	173	75	50	162
20	9951.020	0.570	351 110 661	1	3/4	1	1/4	206	87	52	168



### T-Sensor, dimension independent

- Description: Temperature sensor PT 1000
- Temperature: max. 90°C
- Connection: plug M8

d (inch)	Code	JRG Code	Weight (kg)	G (inch)	l (m)	⊘
1/4	351 110 611	9952.000	0.150	1/4	1	17



# Products

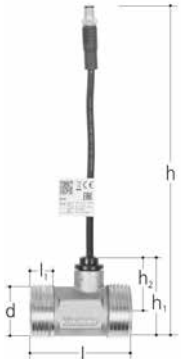

### Flow Sensor, PN 16

- Temperature: max. 90°C
- Material: brass
- Connection: male thread, plug M8

d G	DN	GF	JRG	Weight	l	l1	h	h1	h2
(inch)	(mm)	Code	Code	(kg)	(mm)	(mm)	(mm)	(mm)	(mm)
1	20	<b>351 110 772</b>	<b>9950.020</b>	0.250	60	15	999	49	32



### Drain Surveillance

- Description: to 9910, 9920
- Connection: plug M8
- Consisting of: float switch, bracket, cable, cable ties

GF	JRG	Weight	l	l1	h	b
Code	Code	(kg)	(mm)	(mm)	(mm)	(mm)
<b>351 110 763</b>	<b>9953.000</b>	0.162	1000	24	250	30



### Hycleen Automation power supply and communication cable

- Description: For serial connection of Hycleen Automation System components (master, controller), incl. 2x M12 plugs, ROHS

L	Voltage	JRG	GF	Weight	d	d1
(m)		Code	Code	(kg)	(mm)	(mm)
1.5	36V	<b>9940.001</b>	<b>351 110 581</b>	0.110	14.5	6.8
5	36V	<b>9940.005</b>	<b>351 110 582</b>	0.300	14.5	6.8
10	36V	<b>9940.010</b>	<b>351 110 583</b>	0.630	14.5	6.8
20	36V	<b>9940.020</b>	<b>351 110 584</b>	1.240	14.5	6.8
50	36V	<b>9940.050</b>	<b>351 110 585</b>	3.200	14.5	6.8



### Hycleen Automation Coupling

- Description: Coupling between 2 Hycleen Automation power supply and communication cable
- Connection: plug M12

JRG	Weight	GF	l	h
Code	(kg)	Code	(mm)	(mm)
<b>9941.000</b>	0.100	<b>351 110 586</b>	58	14

# Products



### Sensor Extension Cable

- Description: connection between sensor and controller
- Connection: plug M8

GF Code	JRG Code	Weight (kg)	l (m)	l1 (mm)	l2 (mm)
351 110 662	9943.005	0.110	5	34	42



### Hycleen Automation Relais Cable

Cable to connect the Uni Controller relay connector (24V/230V) with actuators to automate them using the actuator automation application.

- Connection: RD24 plug

l (m)	JRG Code	Weight (kg)	GF Code	l1 (mm)
5	9944.005	0.4	351 110 672	63



### Hycleen Automation 4-20 mA cable

Cable to connect Uni Controller 4-20 mA connectors with actuators. Control and programming of actuators via the master.

- Connection: M12 Plug

l (m)	JRG Code	Weight (kg)	GF Code	l (mm)
5	9945.005	0.2	351 110 674	42

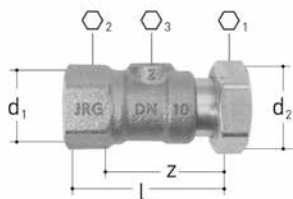

### Union, PN 10

- Description: to 3600, 6320, 6325
- Temperature: max. 90°C
- Connection: female thread
- Consisting of: ball valve, lockable, loose nut

GN (inch)	DN (mm)	JRG Code	GF Code	SP	Weight (kg)	d1 Rp (inch)	d2 G (inch)	l (mm)	○1	○2	○3	z (mm)
½	15	8339.240	350 887 710	1	0.170	½	¾	55	30	27	6	43
¾	20	8339.320	350 887 911	1	0.260	¾	1	55	37	32	6	47

# Products



## Hycleen Automation Commissioning

JRG Code	GF Code
9970.000	351 110 783



## BMS Gateway BACnet IP

- Description: interface for data communication

JRG Code	GF Code
9980.001	351 110 791



## BMS Gateway REST API/JSON

- Description: interface for data communication

JRG Code	GF Code
9980.000	351 110 790



## Master-Relay License

License for activating the Master-Relay module. This license allows you to program the Master Relays using the Actuator Automation application. Further building and process automation is possible. You will receive this module for free after registering your Hycleen Automation System on the Georg Fischer platform.

JRG Code	GF Code
9981.001	35110793



## Actuator Automation module License

License to activate the Actuator Automation Application module. This license allows you to program the Master and Uni Controller relays and the 4-20 mA input/output from the Uni Controller. Further building and process automation is possible.

JRG Code	GF Code
9981.000	35110792

# Worldwide at home

Our sales companies and representatives ensure local customer support in over 100 countries.

[www.gfps.com](http://www.gfps.com)

## Argentina / Southern South America

Georg Fischer Central Plastics Sudamérica S.R.L.  
Buenos Aires / Argentina  
Phone +54 11 4512 02 90  
Fax +54 11 4512 02 93  
[gfcentral.ps.ar@georgfischer.com](mailto:gfcentral.ps.ar@georgfischer.com)  
[www.gfps.com/ar](http://www.gfps.com/ar)

## Australia

George Fischer Pty Ltd  
Riverwood NSW 2210  
Phone +61 (0) 2 9502 8000  
Fax +61 (0) 2 9502 8090  
[australia.ps@georgfischer.com](mailto:australia.ps@georgfischer.com)  
[www.gfps.com/au](http://www.gfps.com/au)

## Austria

Georg Fischer Rohrleitungssysteme GmbH  
3130 Herzogenburg  
Phone +43 (0) 2782 856 43 0  
Fax +43 (0) 2782 856 64  
[austria.ps@georgfischer.com](mailto:austria.ps@georgfischer.com)  
[www.gfps.com/at](http://www.gfps.com/at)

## Belgium / Luxembourg

Georg Fischer NV/SA  
1600 Sint-Pieters-Leeuw / Belgium  
Phone +32 (0) 2 556 40 20  
Fax +32 (0) 2 524 34 26  
[be.ps@georgfischer.com](mailto:be.ps@georgfischer.com)  
[www.gfps.com/be](http://www.gfps.com/be)

## Brazil

Georg Fischer Sist. de Tub. Ltda.  
04571-020 São Paulo/SP  
Phone +55 (0) 11 5525 1311  
[br.ps@georgfischer.com](mailto:br.ps@georgfischer.com)  
[www.gfps.com/br](http://www.gfps.com/br)

## Canada

Georg Fischer Piping Systems Ltd  
Mississauga, ON L5T 2B2  
Phone +1 (905) 670 8005  
Fax +1 (905) 670 8513  
[ca.ps@georgfischer.com](mailto:ca.ps@georgfischer.com)  
[www.gfps.com/ca](http://www.gfps.com/ca)

## China

Georg Fischer Piping Systems Ltd  
201319 Shanghai  
Phone +86 21 3899 3899  
Fax +86 21 3899 3888  
[china.ps@georgfischer.com](mailto:china.ps@georgfischer.com)  
[www.gfps.com/cn](http://www.gfps.com/cn)

## Denmark / Iceland

Georg Fischer A/S  
2630 Taastrup / Denmark  
Phone +45 (0) 7022 1975  
Fax +45 (0) 7022 1976  
[info.dk.ps@georgfischer.com](mailto:info.dk.ps@georgfischer.com)  
[www.gfps.com/dk](http://www.gfps.com/dk)

## Finland

Georg Fischer AB  
01510 Vantaa  
Phone +358 (0) 9 586 58 25  
Fax +358 (0) 9 586 58 29  
[info.fi.ps@georgfischer.com](mailto:info.fi.ps@georgfischer.com)  
[www.gfps.com/fi](http://www.gfps.com/fi)

## France

Georg Fischer SAS  
95932 Roissy Charles de Gaulle Cedex  
Phone +33 (0) 1 41 84 68 84  
Fax +33 (0) 1 41 84 68 85  
[fr.ps@georgfischer.com](mailto:fr.ps@georgfischer.com)  
[www.gfps.com/fr](http://www.gfps.com/fr)

## Germany

Georg Fischer GmbH  
73095 Albershausen  
Phone +49 (0) 7161 302 0  
Fax +49 (0) 7161 302 25 9  
[info.de.ps@georgfischer.com](mailto:info.de.ps@georgfischer.com)  
[www.gfps.com/de](http://www.gfps.com/de)

## India

Georg Fischer Piping Systems Pvt. Ltd.  
400 076 Powai, Mumbai  
Phone +91 22 4007 2000  
Fax +91 22 4007 2020  
[branchoffice@georgfischer.com](mailto:branchoffice@georgfischer.com)  
[www.gfps.com/in](http://www.gfps.com/in)

## Indonesia

PT Georg Fischer Indonesia  
Karawang 41371, Jawa Barat  
Phone +62 267 432 044  
Fax +62 267 431 857  
[indonesia.ps@georgfischer.com](mailto:indonesia.ps@georgfischer.com)  
[www.gfps.com/id](http://www.gfps.com/id)

## Italy

Georg Fischer S.p.A.  
20864 Agrate Brianza (MB)  
Phone +39 02 921 86 1  
Fax +39 02 921 86 24 7  
[it.ps@georgfischer.com](mailto:it.ps@georgfischer.com)  
[www.gfps.com/it](http://www.gfps.com/it)

## Japan

Georg Fischer Ltd  
530-0003 Osaka  
Phone +81 (0) 6 6341 2451  
[jp.ps@georgfischer.com](mailto:jp.ps@georgfischer.com)  
[www.gfps.com/jp](http://www.gfps.com/jp)

## Korea

Georg Fischer Piping Systems  
463-824 Seoul  
Phone +82 31 8017 1450 3  
Fax +82 31 8017 1454  
[kor.ps@georgfischer.com](mailto:kor.ps@georgfischer.com)  
[www.gfps.com/kr](http://www.gfps.com/kr)

## Malaysia

George Fischer (M) Sdn. Bhd.  
41200 Klang, Selangor Darul Ehsan  
Phone +60 (0) 3 3122 5585  
Fax +60 (0) 3 3122 5575  
[my.ps@georgfischer.com](mailto:my.ps@georgfischer.com)  
[www.gfps.com/my](http://www.gfps.com/my)

## Mexico / Northern Latin America

Georg Fischer S.A. de C.V.  
CP 66636 Apodaca, Nuevo Leon / Mexico  
Phone +52 (81) 1340 8586  
Fax +52 (81) 1522 8906  
[mx.ps@georgfischer.com](mailto:mx.ps@georgfischer.com)  
[www.gfps.com/mx](http://www.gfps.com/mx)

## Middle East

Georg Fischer Piping Systems (Switzerland) Ltd  
Dubai / United Arab Emirates  
Phone +971 4 289 49 60  
Fax +971 4 289 49 57  
[gss.ps@georgfischer.com](mailto:gss.ps@georgfischer.com)  
[www.gfps.com/int](http://www.gfps.com/int)

## Netherlands

Georg Fischer N.V.  
8161 PA Epe  
Phone +31 (0) 578 678 222  
Fax +31 (0) 578 621 768  
[nl.ps@georgfischer.com](mailto:nl.ps@georgfischer.com)  
[www.gfps.com/nl](http://www.gfps.com/nl)

## New Zealand

Georg Fischer Ltd  
5140 Upper Hutt  
Phone +64 (0) 4 527 9813  
Fax +64 (0) 4 527 9834  
[nz.ps@georgfischer.com](mailto:nz.ps@georgfischer.com)  
[www.gfps.com/nz](http://www.gfps.com/nz)

## Norway

Georg Fischer AS  
1351 Rud  
Phone +47 67 18 29 00  
Fax +47 67 13 92 92  
[no.ps@georgfischer.com](mailto:no.ps@georgfischer.com)  
[www.gfps.com/no](http://www.gfps.com/no)

## Philippines

Georg Fischer Pte. Ltd.  
Philippines Representative Office  
1500 San Juan City  
Phone +632 571 2365  
Fax +632 571 2368  
[sgp.ps@georgfischer.com](mailto:sgp.ps@georgfischer.com)  
[www.gfps.com/sg](http://www.gfps.com/sg)

## Poland

Georg Fischer Sp. z o.o.  
05 090 Sekocin Nowy  
Phone +48 (0) 22 3131 050  
Fax +48 (0) 22 3131 060  
[poland.ps@georgfischer.com](mailto:poland.ps@georgfischer.com)  
[www.gfps.com/pl](http://www.gfps.com/pl)

## Romania

Georg Fischer Rohrleitungssysteme (Elvetia)  
S.A. SUCURSALA BUCURESTI  
020257 Bucuresti  
Phone +40 311 040 492  
Fax +40 212 317 479  
[ro.ps@georgfischer.com](mailto:ro.ps@georgfischer.com)  
[www.gfps.com/int](http://www.gfps.com/int)

## Russia

Georg Fischer Piping Systems (Switzerland) Ltd  
Moscow Representative Office  
125040 Moscow  
Phone +7 495 748 11 44  
[ru.ps@georgfischer.com](mailto:ru.ps@georgfischer.com)  
[www.gfps.com/ru](http://www.gfps.com/ru)

## Singapore

Georg Fischer Pte Ltd  
528 872 Singapore  
Phone +65 6747 0611  
Fax +65 6747 05 77  
[sgp.ps@georgfischer.com](mailto:sgp.ps@georgfischer.com)  
[www.gfps.com/sg](http://www.gfps.com/sg)

## Spain / Portugal

Georg Fischer S.A.  
28046 Madrid / Spain  
Phone +34 (0) 91 781 98 90  
Fax +34 (0) 91 426 08 23  
[es.ps@georgfischer.com](mailto:es.ps@georgfischer.com)  
[www.gfps.com/es](http://www.gfps.com/es)

## Sweden

Georg Fischer AB  
11743 Stockholm  
Phone +46 (0) 8 506 77 50 0  
Fax +46 (0) 8 749 23 70  
[info.se.ps@georgfischer.com](mailto:info.se.ps@georgfischer.com)  
[www.gfps.com/se](http://www.gfps.com/se)

## Switzerland

Georg Fischer Rohrleitungssysteme (Schweiz) AG  
8201 Schaffhausen  
Phone +41 (0)52 631 3026  
Fax +41 (0)52 631 2800  
[ch.ps@georgfischer.com](mailto:ch.ps@georgfischer.com)  
[www.gfps.com/ch](http://www.gfps.com/ch)

## Taiwan

Georg Fischer Co. Ltd.  
24158 New Taipei City  
Phone +886 2 8512 2822  
Fax +886 2 8512 2823  
[tw@georgfischer.com](mailto:tw@georgfischer.com)  
[www.gfps.com/tw](http://www.gfps.com/tw)

## Turkey

Georg Fischer Hakan Plastik  
Boru ve Profil San. Tic. A.Ş.  
59500 Cerkezkoy / Tekirdag  
Phone +90 282 726 64 43  
Fax +90 282 726 94 67  
[hpsales@hakan.com.tr](mailto:hpsales@hakan.com.tr)  
[www.hakan.com.tr](http://www.hakan.com.tr)

## United Kingdom / Ireland

Georg Fischer Sales Ltd  
CV2 2ST Coventry / United Kingdom  
Phone +44 (0) 2476 535 535  
Fax +44 (0) 2476 530 450  
[uk.ps@georgfischer.com](mailto:uk.ps@georgfischer.com)  
[www.gfps.com/uk](http://www.gfps.com/uk)

## USA / Caribbean

Georg Fischer LLC  
92618 Irvine, CA / USA  
Phone +1 714 731 88 00  
Fax +1 714 731 62 01  
Toll Free 800/854 40 90  
[us.ps@georgfischer.com](mailto:us.ps@georgfischer.com)  
[www.gfps.com/us](http://www.gfps.com/us)

## Vietnam

Georg Fischer Pte Ltd  
Representative Office  
Ho Chi Minh City  
Phone +84 28 3948 4000  
Fax +84 28 3948 4010  
[sgp.ps@georgfischer.com](mailto:sgp.ps@georgfischer.com)  
[www.gfps.com/vn](http://www.gfps.com/vn)

## International

Georg Fischer Piping Systems (Switzerland) Ltd  
8201 Schaffhausen / Switzerland  
Phone +41 (0) 52 631 3003  
Fax +41 (0) 52 631 2893  
[info.export@georgfischer.com](mailto:info.export@georgfischer.com)  
[www.gfps.com/int](http://www.gfps.com/int)

The technical data are not binding. They neither constitute expressly warranted characteristics nor guaranteed properties nor a guaranteed durability. They are subject to modification. Our General Terms of Sale apply.



37 780 62  
e / 03.21 / DH  
© Georg Fischer JRG AG  
Hauptstrasse 130  
CH-4450 Sissach/Switzerland  
Telefon +41 (0) 61 975 22 22  
[info.jrg.ps@georgfischer.com](mailto:info.jrg.ps@georgfischer.com)  
Printed in Switzerland